

Thank you for purchasing this Olympus digital camera.

This Quick Start Guide provides you with the information you need to start using your new Olympus camera right away. This guide is also useful for checking the button locations and names when you are reading the Instructions booklet.

Refer to the Instructions provided with the camera for detailed information on using your Olympus camera.

1. Getting Started

Loading the batteries

1. Follow the steps below to load the batteries.

Before loading the batteries, check that the Mode dial is set to "OFF".

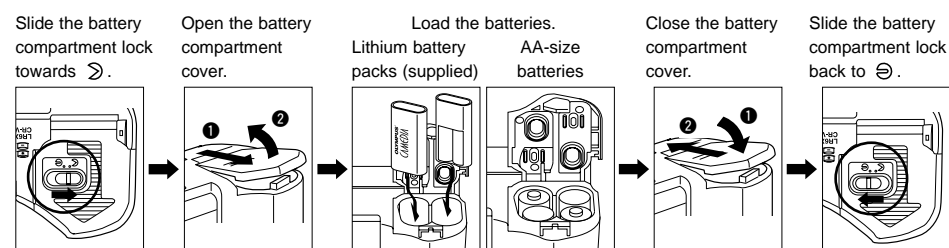

- * When you close the battery compartment cover, press down on the cover to hold the batteries down.
- * Do not use manganese batteries.

2. Insert the SmartMedia (card).

* Before inserting the card, check that the camera is switched off and that nothing is displayed on the control panel.

Open the card cover and push the card in fully in the direction indicated by the arrow. (The card is used to record the pictures you take.)

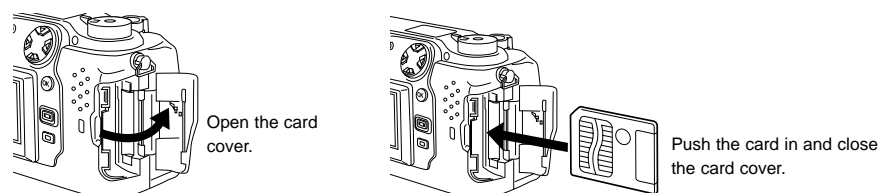

Use the Mode dial to select the camera operation mode. If you are using the camera for the first time, the "P" (Program mode) setting provides a quick and easy way to take pictures.

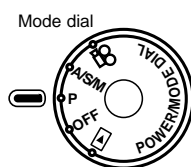

[Still picture shooting mode]

P: Program mode. This mode allows you to take beautiful pictures simply by pressing the shutter button.

A/S/M: The default mode for this setting is Aperture Priority mode, in which you select the aperture setting. You can also select Shutter Priority mode, in which you set the shutter speed, and Manual mode, in which you set both the aperture and the shutter speed.

[Movie record mode]

RECORD: Select this mode when you want to shoot a movie.

[Playback mode]

REVIEW: Select this mode when you want to view the shots you have taken.

[Camera off]

OFF: Switches the camera off.

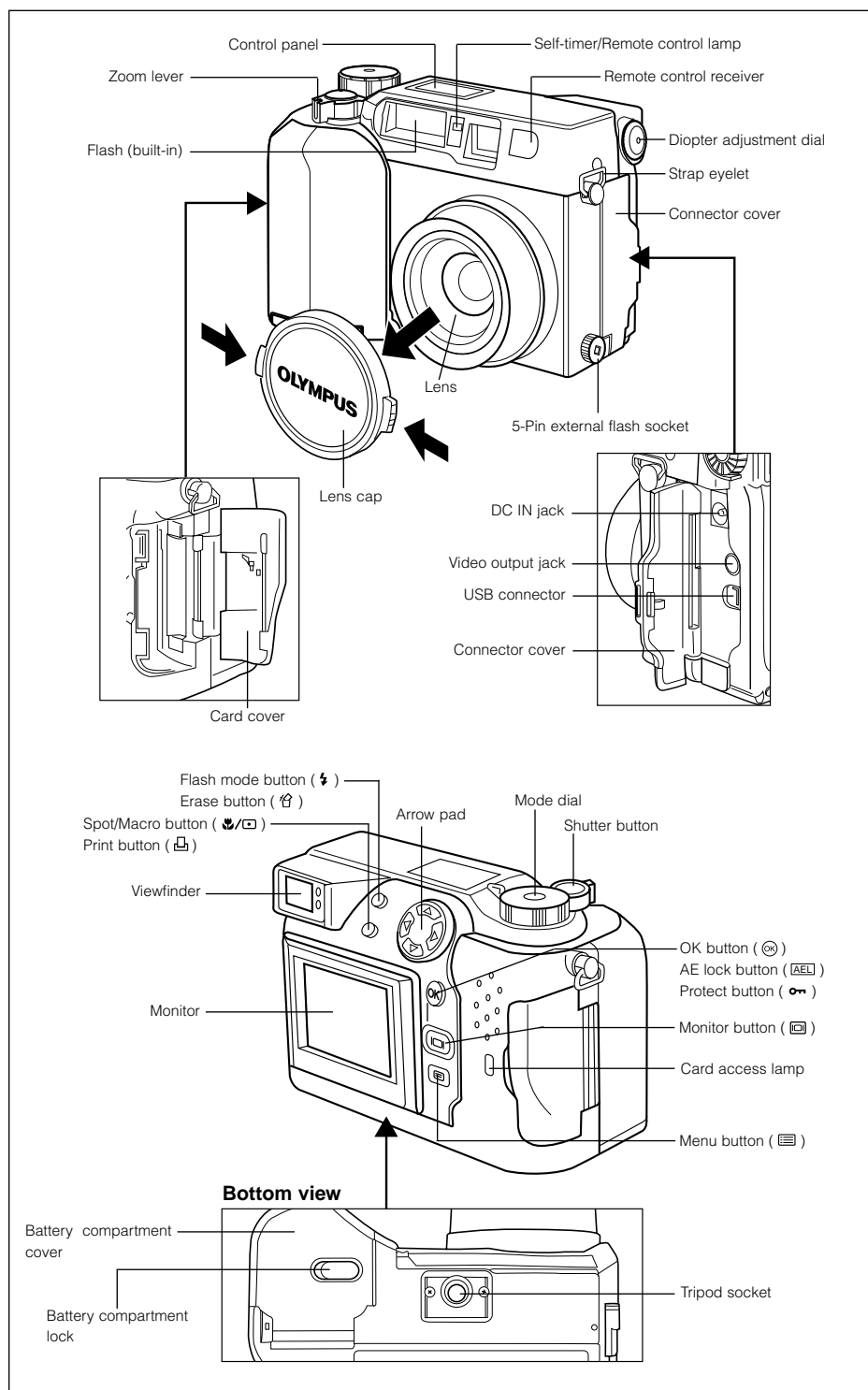

Adjusting the Viewfinder for Easier Viewing

Turn the diopter adjustment dial to adjust the viewfinder until you can see the AF target mark clearly.

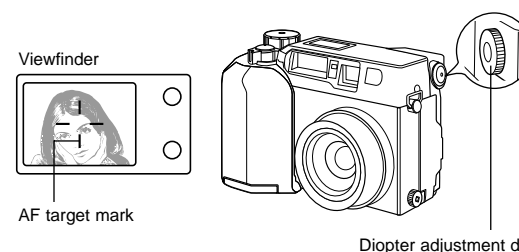

Setting the Date and Time

1. Press in the release buttons on both sides of the cap to remove the lens cap.
2. Set the Mode dial to "P" (Program mode).
3. Press the (Menu) button.
The menu screen appears on the Monitor.
4. Press on the Arrow pad to move the green highlighting frame so that "MODE SETUP" is selected. Then press .

"SETUP" appears on the Monitor.
The selected option is displayed in green.

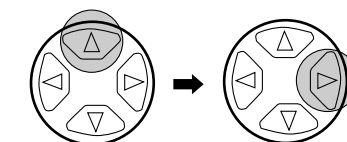

5. Press the [OK] button.

The MODE SETUP screen appears.

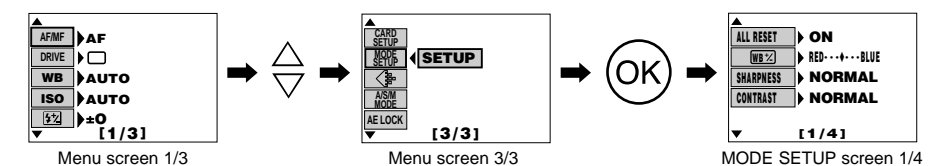

6. Press on the Arrow pad to select and then press .

"SETUP" appears. (To return to the previous page, move the green selection frame to the top of the screen and then press on the Arrow pad.)

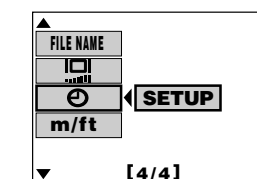
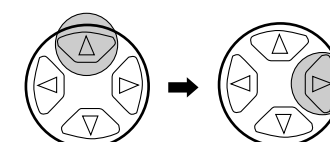

7. Press the [OK] button.

The date/time setting screen appears.

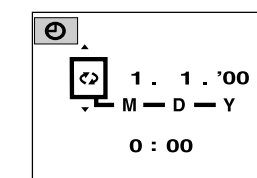

Date time setting screen

8. Press or on the Arrow pad to select the date format. (You can select day/month/year, month/day/year or year/month/day.)
9. Press on the Arrow pad and then or to set the date and time. To move to the next setting (month → day), press on the Arrow pad. To move back (day → month), press .

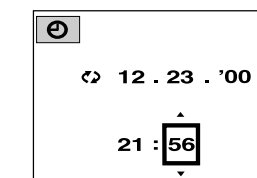

10. When you have finished setting the date and time, press the [OK] button.

11. Press the [OK] button repeatedly until you exit the menu screen.

2. Shooting

Taking Pictures

1. Remove the Lens cap and set the Mode dial to "P" (Program mode).

2. Point the camera at your subject. Look through the viewfinder and point the camera at the person or object you want to photograph (the subject).

Position the AF target mark over the subject. You can also look at the image on the Monitor to take pictures.

Press the [Monitor] button to switch the Monitor on and off.

[To zoom in]

By turning the zoom lever to "T", you can enlarge the picture of your subject. When you turn the zoom lever towards "W", the image reverts to the size it was when you switched the camera on, allowing you to shoot a wider area.

3. Focus on your subject. (Press the shutter button down halfway.)

With the camera pointed at your subject, press the shutter button down lightly.

The camera gives 2 short beeps and the green lamp lights. At this point, the focus and exposure (shutter speed and aperture setting) are locked. If the green lamp blinks, this indicates that the camera cannot focus. Release the shutter button, move the position of the AF target mark slightly and then lightly press the shutter button again.

4. Take the picture. (Press the shutter button down fully.)

With the shutter button pressed down halfway, press it down further so it is fully depressed. The camera gives a short beep and takes the picture.

The camera then starts recording the image onto the card and the card access lamp blinks.

If the green lamp light up when you press the shutter button, you can take another picture, even if an image is being recorded onto the SmartMedia card. If you are taking a picture in low-light conditions, the flash will fire automatically.

When your subject is not in the center of the shot (focus lock)

First, position the AF target mark over your subject and press the shutter button halfway to focus the camera. Then hold the shutter button down as you move the camera to compose the shot as you want it and, without releasing the shutter button, press the shutter button down fully to take the shot.

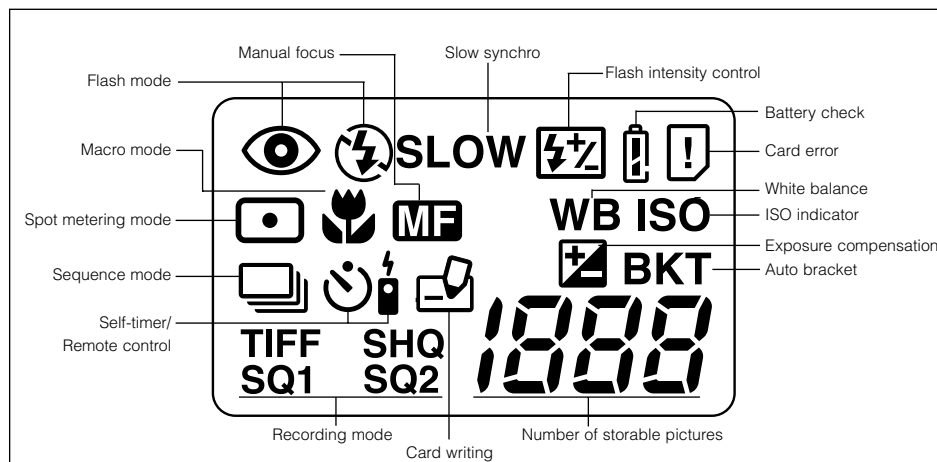
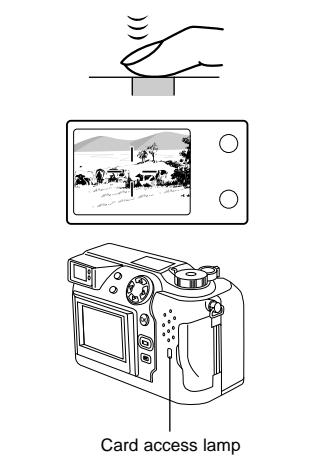
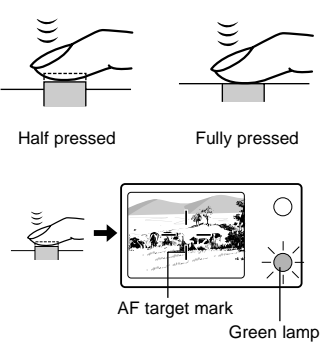
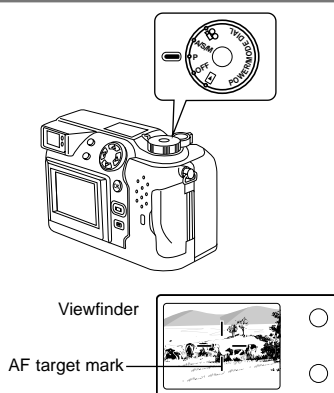

Available functions from button on C-2040ZOOM

Flash Mode Button

The flash mode changes each time you press this button. The available flash modes are "Auto-Flash", in which the flash fires automatically in low-light and backlit conditions, "Red-Eye Reduction Flash" (☉), which reduces the "red-eye" effect (where the subject's eyes appear red), "Forced Flash" (⚡), in which the flash fires for every shot regardless of the conditions, and "Flash Off" (⊕), in which the flash never fires, even in low-light conditions.

Spot/Macro Button

The light metering mode or Macro mode changes each time you press the Spot/Macro button. The available modes are "Normal", which is used for normal autofocus photography, "Spot Metering mode" (☐), which measures light only at the center of the shot and is useful for shots such as dark subjects in backlit shots, "Macro mode" (👁), which allows you to focus on subjects 7.9" to 31.5" from the camera, and "Macro + Spot Metering mode" (☐👁), which measures light only at the center of a close-up subject.

Shooting Movies

1. Set the Mode dial to [Movie].

The Monitor switches on and displays the available shooting time.

2. Shoot in the same way as for "P" mode.

The camera starts shooting when you press the shutter button down. Press the shutter button again to end shooting. The lowest memory gauge lights, the card access lamp blinks and the camera starts recording the movie onto the card. You can continue shooting when the lamp stops blinking and the camera finishes recording data onto the card.

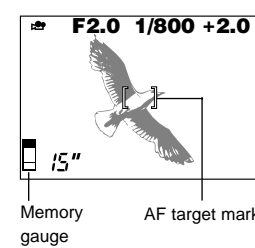

3. Viewing Your Shots

Set the Mode dial to [Review].

* The most recent shot is displayed on the Monitor (Single-frame playback).

- Use the Arrow pad to select the image you want to view.
 - ◀: Displays the previous shot.
 - ▶: Displays the next shot.
 - △: Jumps back 10 shots.
 - ▽: Jumps forward 10 shots.

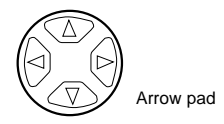

- * To display multiple shots (Index playback), turn the zoom lever to "W".
- * To display a shot enlarged (in close up), turn the zoom lever to "T".



You can display images marked with the [Movie] icon as movies. Press the [Menu] button and use the Arrow pad to select "MOVIE PLAY" and then press [OK]. When "START" appears, press the [OK] button. When the card access lamp stops blinking, the movie starts playing. When the movie ends, press the [Menu] button to display the menu and then press the Menu button again to exit Movie playback mode.

- When a movie is running, you can use the Arrow pad to do the following:
 - △: Jump to the start of the current movie.
 - ▽: Jump to the end of the current movie.
 - ▶: Play the movie for as long as the button is held down.
 - ◀: Play the movie in reverse for as long as the button is held down.
- [OK] button: Pause the movie. Press this button again after the movie has finished to play the movie again.



4. Erasing Pictures

You can erase pictures you no longer need by erasing them one at a time (one-frame erase) or by erasing all the images on the card (all-frame erase). Use the steps in "3. Viewing Your Shots" to display the image you want to erase.

One-frame Erase

Press the Erase button on the camera, use the Arrow pad to select "YES" and then press the [OK] button.



All-frame Erase

Press the [Menu] button and use the Arrow pad to select "CARD SETUP" and then press [OK]. Press △ or ▽ to select "🗑" and then press the [OK] button. Select "YES" in the confirmation screen and then press the [OK] button again. (To cancel image erasing, select "NO" and press the [OK] button.)

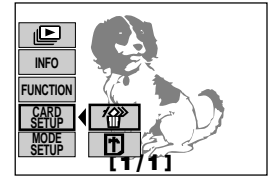

This screen shows the still picture playback menu.

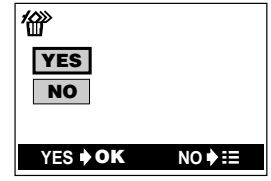

Confirmation screen

5. Switch the camera off when you've finished shooting.

Always switch the camera off when you have finished taking pictures. Check that the card access lamp is no longer blinking and then set the Mode dial to "OFF".

- The Monitor and control panel go blank.
- If you leave the camera switched on without using it in any way for 3 minutes or longer, the Monitor and control panel automatically go blank to conserve battery power. (This is referred to as Sleep mode.) To revive the camera when it is in Sleep mode, simply press any of the camera's controls.
- Always fit the lens cap when you put the camera away.