

OLYMPUS®

NEWPIC ZOOM 90

INSTRUCTIONS

Before using your camera, read this manual carefully to ensure correct use.



ADVANCED TECHNIQUES
TECHNIQUES AVANCÉES
TECNICAS AVANZADAS

CAMERA MAINTENANCE
ENTRETIEN DE L'APPAREIL
MANTENIMIENTO DE LA
CAMARA

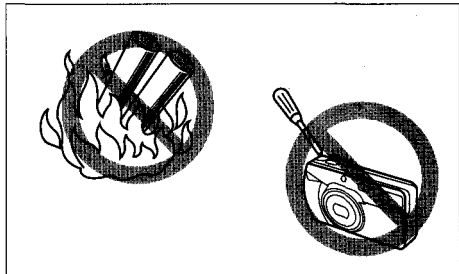

Thank you for purchasing an Olympus camera. Before you start to use your new camera, please read these instructions carefully to obtain optimum performance and a longer service life from the unit.

WARNING



Ignoring this warning may result in the death or serious injury of the user.

KEEP THE BATTERIES AWAY FROM FIRE.
NEVER TRY TO DISASSEMBLE, RECHARGE, OR
SHORT CIRCUIT BATTERIES.

NEVER ATTEMPT TO DISASSEMBLE THE CAMERA;
IT CONTAINS A HIGH VOLTAGE CIRCUIT.
IF THE INTERNAL PARTS OF THE CAMERA ARE
EXPOSED DUE TO DROPPING OR DAMAGE,
REMOVE THE BATTERIES IMMEDIATELY TO
PREVENT FURTHER USAGE.

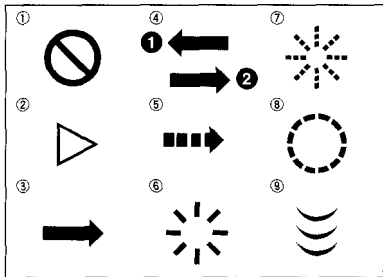

- Before using your camera, read this manual carefully to ensure correct use.
- We recommend that you take test shots to get accustomed to your camera before taking important photographs.

MAIN FEATURES

- Built-in 30mm - 90mm 3X zoom lens.
- Use IX240 cartridge film for simple one-touch film loading.
- Three types of prints (C, H, P) can be obtained by setting the selector switch.
- A magnetic head records important printing data on the film.

* Use only processors displaying the  mark when requesting film development and printing.

Symbols used in this manual:

- | | | |
|--------------------|-----------------------|----------------------|
| ① Incorrect | ④ Operation order | ⑦ Indicator blinking |
| ② Next operation | ⑤ Automatic operation | ⑧ Attention |
| ③ Manual operation | ⑥ Indicator on | ⑨ Depress halfway |

Pay particular attention to items in this manual enclosed in boxes .

Product shown in pictures and illustrations may be slightly different from this unit.









PREPARATIONS

Names and functions of parts	6
Viewfinder display/LCD panel	8
Cartridge	9
Diopter adjustment	11
Using the strap/soft case	11
Outline of operations	12
Loading the battery	15
Checking the battery	16
Points to remember	17

BASIC OPERATIONS

Loading the cartridge film	19
Taking pictures	21
Using the focus lock	24
After shooting	25
Unloading the cartridge film	26

ADVANCED TECHNIQUES

Setting the print type	27
Using the shooting modes	32
Auto Flash	34
 Red-eye Reducing Flash	35
 Off (Flash Override)	36
 Fill-In Flash (Forced Activation)	37
 Landscape	38
 Night Scene Flash	39
 Red-eye Reducing Night Scene Flash	40
 Selftimer	41
 Remote control (optional)	42
Correcting the data	44
Printing the date and time	46

CAMERA MAINTENANCE

Questions and answers	47
Care and storage	49
Battery handling	52
Remote control (optional) handling	54
Troubleshooting	55
Specifications	58

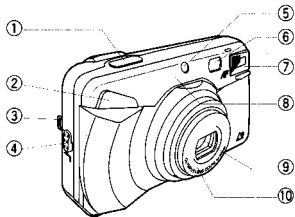

NAMES AND FUNCTIONS OF PARTS

- ① Shutter release button
- ② Selftimer signal
- ③ Strap eyelet
- ④ Cartridge cover release lever (p. 19)
- ⑤ Light sensor*
- ⑥ Viewfinder
- ⑦ Flash*
- ⑧ Autofocus window*
- ⑨ Lens*
- ⑩ Lens barrel

* Do not soil as this can cause blurred pictures.
Wipe clean with a soft cloth.

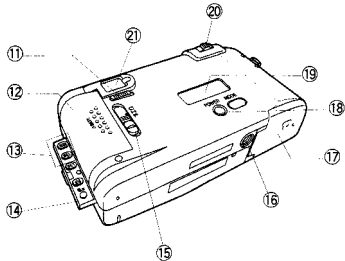

- ① Diopter adjustment lever
- ② Battery compartment cover (p. 15)
- ③ Quartz date mode buttons (p. 44)
- ④ Control panel
- ⑤ Print type selector switch (p. 27)
- ⑥ Tripod socket
- ⑦ Cartridge cover
- ⑧ Power switch (p. 16)
- ⑨ LCD panel
- ⑩ Zoom lever (p. 21)
 - T—telephoto
 - W—wide-angle
- ⑪ Viewfinder

VIEWFINDER DISPLAY/LCD PANEL

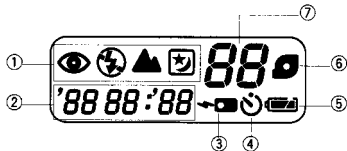
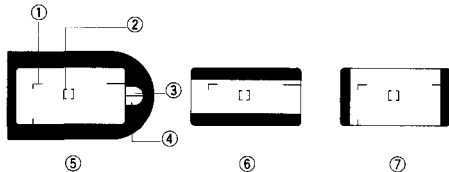

VIEWFINDER DISPLAY

- ① Close-up correction marks (p. 23)
- ② Autofocus frame
Position your subject within the autofocus frame.
- ③ Green lamp
- ④ Redlamp
- ⑤ Htype
- ⑥ P type
- ⑦ C type

LCD PANEL

- ① Shooting mode display (p. 32)
- ② Quartz date mode display (p. 44)
- ③ Remote control display
- ④ Selftimer display (p. 41)
- ⑤ Battery check
- ⑥ Cartridge mark
Lights when a cartridge is loaded.
- ⑦ Exposure counter display

- * The viewfinder format changes in accordance with the print type selected (p. 27).
- * The LCD panel does not actually display all indications simultaneously as shown.

CARTRIDGE

IX 240 Cartridge Film

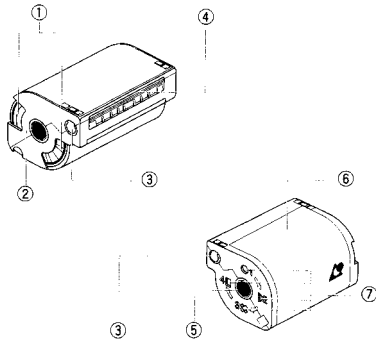

- ① Data disk
- ② Cartridge spool
- ③ Lightlock door drive
- ④ Lightlock door
- ⑤ Cartridge spool
- ⑥ Cartridge label
- ⑦ Visual Exposure Indicator

- Never apply undue force to the cartridge spool, lightlock door drive or lightlock door because this can result in damage or exposure of the film. Using a damaged cartridge can cause camera trouble.
- Do not allow the data disk to become soiled because this can render the cartridge unusable.

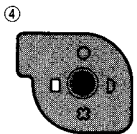
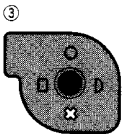
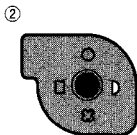
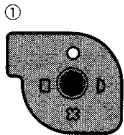

Understanding the Visual Exposure Indicator

① (○) Unexposed

② (◐) Partially exposed

③ (✱) Exposed

④ (◻) Processed

- Only cartridges with the ○ (unexposed) visual exposure indicator can be used with this camera.
- When a cartridge with other than the ○ visual exposure indicator is loaded, the camera will rewind the film and set the cartridge to ✱ (exposed).
- Take along plenty of film cartridges when traveling to foreign countries and other areas where cartridge purchasing may be difficult.
- Do not forcibly move the visual exposure indicator because this may damage the cartridge. Using a damaged cartridge can result in camera trouble.

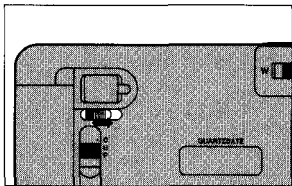

DIOPTRER ADJUSTMENT

To Adjust the Viewfinder to Compensate for Near-and far-sighted Vision

Slide the diopter adjustment lever until the viewfinder display becomes clear.

Slide to the right if you are far-sighted or to the left if you are near-sighted.

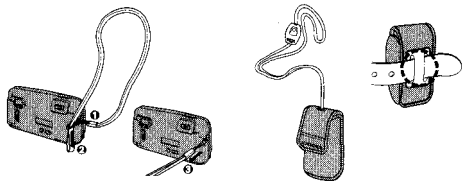

USING THE STRAP/SOFT CASE

The soft case can also be carried on a belt.

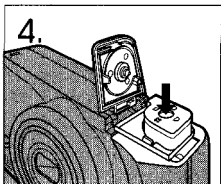
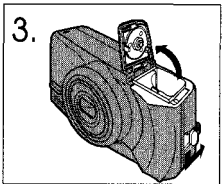
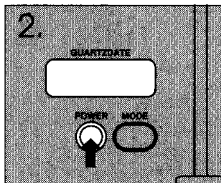
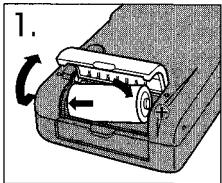

OUTLINE OF OPERATIONS

Basic Shooting Procedures

1. Load a battery (p. 15).
2. Turn on the power switch.
Make sure
■ mark is not displayed on the LCD panel.
3. Open the cartridge cover (p. 19).
4. Insert a cartridge (p. 20).

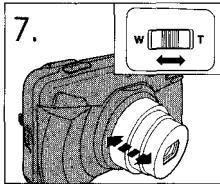
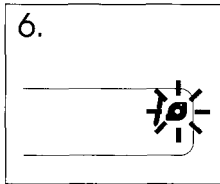
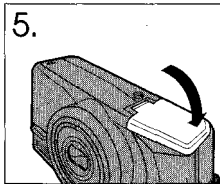

5. Close the cartridge cover. The film will automatically advance to the first frame (p. 20).

6. Make sure  is displayed and the exposure counter reads 1.

7. Operate the zoom lever to compose the scene (p. 21).

8. Place the autofocus frame on the subject on which you want to focus (p. 22).

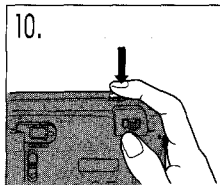
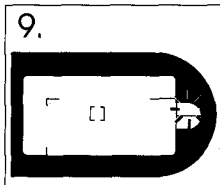

9. Press the shutter release button halfway to make sure the green lamp lights.

10. Press the shutter release button fully and take the picture (p. 22).
The shutter will not release when the red lamp is blinking.

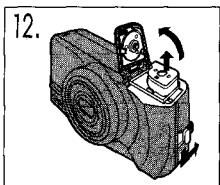
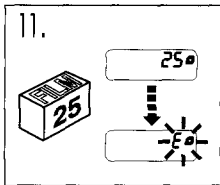

11. When the film reaches the end, it will automatically rewind (p. 26).
E will be displayed on the LCD panel.

12. Open the cartridge cover and remove the cartridge (p. 26).

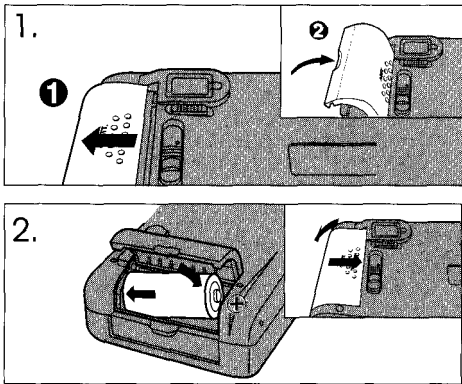

LOADING THE BATTERY

Use one 3V lithium battery (DL123A or CR123A)

1.
 - 1 Slide the battery compartment cover.
 - 2 Open the cover as shown.
When replacing the battery, make sure to turn the power switch OFF before unloading the batteries.
2. Insert the new battery correctly as shown and close the battery compartment cover tightly.
Align the (+) and (-) directions of the batteries correctly as shown.

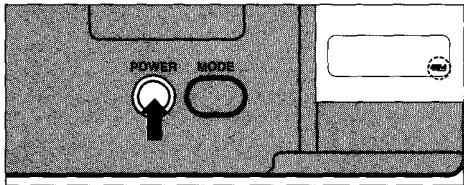

Read "Battery Handling" on page 52.



CHECKING THE BATTERY

Turn the power switch ON and check the battery condition.

Immediately after the battery has been replaced, the battery power level may not be accurately displayed on the LCD panel. Turn the power switch ON to check the accurate battery power level.

Display	Meaning
 lights.	Battery is OK.
 lights.	Battery is low and should be replaced.
 blinks.	Battery is dead and should be replaced immediately.

Note: Keep spare batteries on hand when going on a long trip or when using the camera in cold weather. Adjust the data of the quartz date every time the battery is replaced.

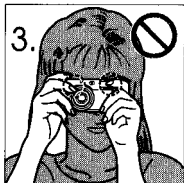
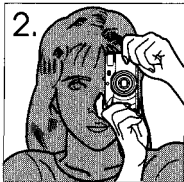
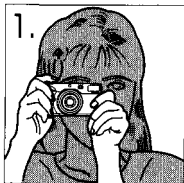

POINTS TO REMEMBER

Hold the Camera Correctly.

1. Correct.
2. Correct.
3. Incorrect.

- Try not to hold the barrel.
- Keep your fingers and the strap away from the lens and flash.
- As the focal length becomes larger, camera shake or movement becomes more noticeable. Hold the camera firmly with both hands while keeping your elbows at sides to prevent the camera from shaking.
- In the vertical position, hold the camera with its flash positioned at the top.

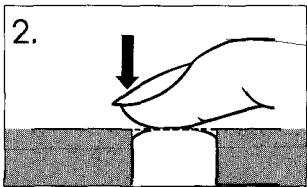
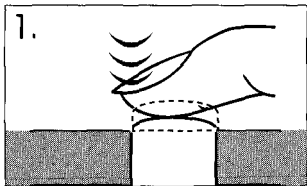

Proper Shutter Release.

The shutter release button has two clicks. Practice before loading the film.

1. Depress the shutter release button halfway to lock the focus.
Focus and exposure will be locked properly.

Make sure

The green lamp next to the viewfinder lights.

2. Depress the shutter release button fully to release the shutter and take the picture.

Cautions:

- Press the shutter release button gently.
- Avoid shaking the camera when pressing the shutter release button to prevent blurry pictures.

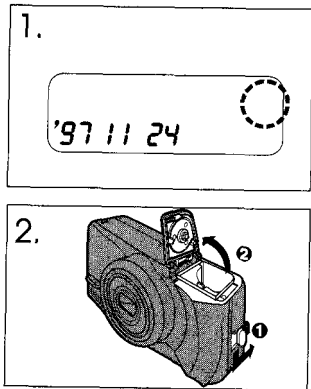

LOADING THE CARTRIDGE FILM

This camera uses IX240 cartridges. Just load the cartridge; the camera does the rest automatically.

1. Make sure  is not displayed on the LCD panel.

Note: Use only cartridges with the  (Unexposed) visual exposure indicator (p. 10).

2.
 - 1 Move the cartridge cover release lever as shown.
 - 2 Open the cartridge cover.

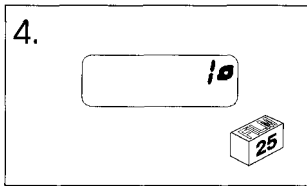
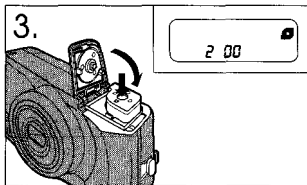

3. Insert the cartridge correctly and close the cartridge cover.

The film will advance automatically to the first frame.

While the film is advancing to the first frame, the film speed is displayed on the LCD panel.

4. Make sure the exposure counter reads 1.

If **E** or **■** appears blinking, the film will not advance properly. Check the cartridge to ensure the **○** (unexposed) visual exposure indicator appears.

TAKING PICTURES

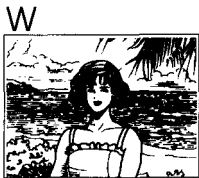
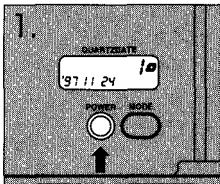

1. Set the power switch to ON.
Make sure
The lens barrier opens and the lens extends.
2. Look through the viewfinder, press the Zoom lever and compose the picture.

⚠ Do not look directly at the sun through the viewfinder.

On TELE, the lens can zoom-in to 90mm.
On WIDE, the lens can zoom-out to 30mm.

- The zoom changes focal length at seven steps.
- The power will automatically turn off when the camera is not in use for more than 5 minutes.

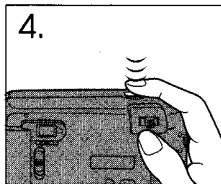

3. Position the subject inside the autofocus frame.

4. Depress the shutter release button halfway.

The exposure is measured automatically when the lens extends, the camera focuses on the subject, and the green lamp lights.

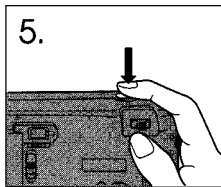
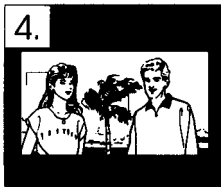

To take a picture with the subject outside the autofocus frame as shown here, use the focus lock (p. 24).

5. Depress the shutter release button fully to take the picture.

The film automatically advances to the next frame, and the exposure counter increases by one digit.

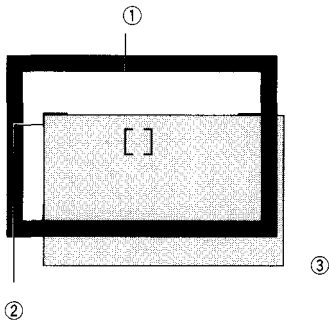

Working Distance

The focus range of the camera is 0.6 m (2 ft) to ∞ (Infinity). The camera cannot focus on a subject that is closer than 0.6 m (2 ft) even though the shutter still releases and the green lamp blinks.

- When the shutter release button is pressed halfway, the image in the viewfinder gets larger, but this does not affect the final image in the picture.
- Focus is adjusted automatically by the autofocus but, depending on the conditions, the autofocus may have difficulty focusing on some subjects (p. 47).

Close-up Correction

- ① Picture frame
- ② Close-up correction marks
- ③ Image area of picture at 0.6 m (2ft)

The viewfinder's picture frame shows the area that can be shot for subjects at ∞ . However, the picture area will move lower in the viewfinder as you get closer to the subject. At 0.6 m (2ft), the shaded area is the actual available image area. In this case, the subject should be positioned below the close-up correction marks.

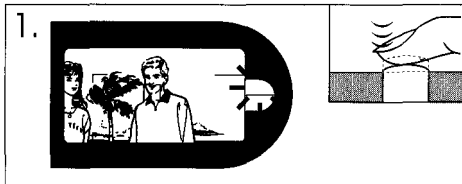

USING THE FOCUS LOCK

To avoid taking out of focus pictures.

The focus lock is used when the subject is outside the autofocus frame.

1. Position the subject within the autofocus frame and press the shutter release button halfway.
 - The exposure will also be locked at this time. The autofocus lock is released when the finger is removed from the shutter release button.
2. Still pressing the shutter release button lightly, recompose the scene as desired and then fully press the shutter release button to take the picture.

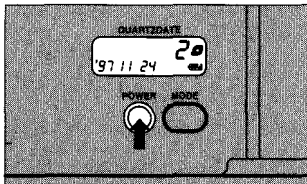

AFTER SHOOTING

Turn the power switch to OFF.

Make sure

The lens is retracted and the lens barrier is closed.

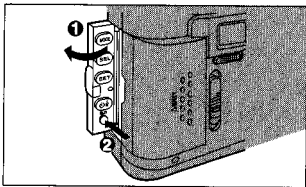
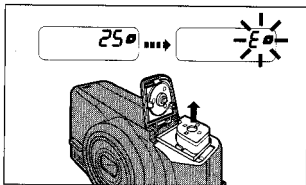

UNLOADING THE CARTRIDGE FILM

The film will be rewound automatically when the end of the roll is reached.

- Wait until the sound of the motor operation stops and ϵ is displayed in the exposure counter. Then open the cartridge cover and remove the cartridge. The cartridge visual exposure indicator will be set to \odot (exposed).

Rewinding in Mid-roll

To rewind the film in mid-roll: ① Open the control panel. ② Use a pointed object such as a ballpoint pen to lightly press the mid-roll rewind button.

- The cartridge visual exposure indicator \odot (exposed) is set even when the film is rewound before the end is reached. Because of that cartridges cannot be re-used after being rewound in mid-roll. However, the visual exposure of cartridges that were rewound when no exposure have been made will remain \circ (Unexposed). This cartridge can be used even when rewound.
- Do not forcibly move the visual exposure indicator because this may damage the cartridge. Using a damaged cartridge can result in camera trouble.

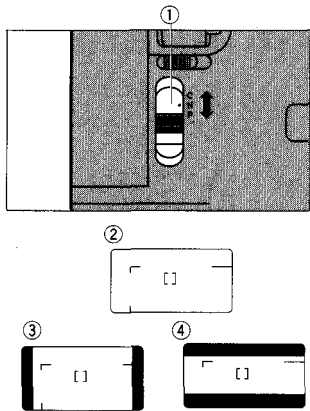

SETTING THE PRINT TYPE

Setting the Print Type

Set the print type selector switch to the desired type: C, H or P.

- ① Print type selector switch
- ② **H type** viewfinder
- ③ **C type** viewfinder
- ④ **P type** viewfinder

Always keep the print type selector switch set correctly. The print type setting is magnetically recorded on the film. The number of exposures does not change even when the print type is changed.

Print area on film

Print



C



H

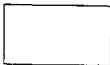

P



Print Type Setting Configuration

For H type prints, the images are printed without change. With C type, the left and right sides of the images are cut. With P type, the tops and bottoms of the images are cut. The aspect ratios of the three print types are shown in the table below.

Print type	Aspect ratio
C type	Approx. 2:3
H type	Approx. 9:16
P type	Approx. 1:3

The negatives cannot be seen.

Requesting Development and Printing

Use only processors displaying the  mark when requesting film developing and printing. The developed film will be returned in the cartridge. The prints will be marked with the same ID number found on the film, as shown on page 30.

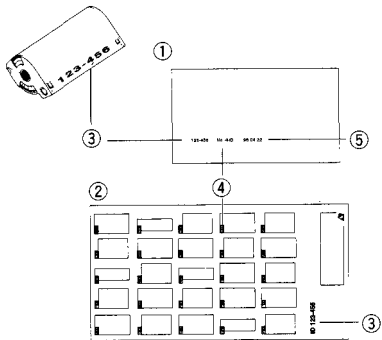

- ① Print rear surface (example)
- ② Index prints (example)
- ③ ID number
- ④ Frame number
- ⑤ Date

Ask your local processor for details concerning index prints.

Making Additional Prints (Extra printing)

1. Make sure that the cartridge ID number is the same as the ID numbers on the backs of the regular prints or index prints to be copied before taking the cartridge to the processor.
2. Use the frame numbers printed on the backs of the regular prints or index prints when ordering additional copies.

- Print prices will differ depending on the print type.
- The handling of index prints will differ depending on the processor.
Ask your local processor for details.

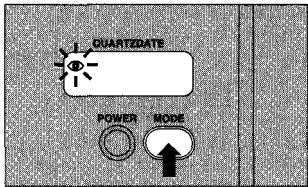

USING THE SHOOTING MODES

This camera has seven shooting modes. Use these modes in accordance with the photographic conditions and your purpose.

Setting the Modes

Each time the shooting mode button is pressed, the mode will change sequentially as shown on page 33.

Warning: Do not use the flash when the camera is extremely close to the eyes of people and animals. This will temporarily impair eyesight.

LCD Panel Display

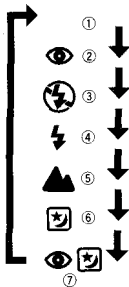

	Mode	Function/Application
①	Auto Flash	Automatically fires in low-light conditions (p. 34)
②	Red-eye Reducing Flash	Significantly reduces the phenomenon of "red-eye" (when a subject's eyes appear red in flash photos). (p. 35)
③	Off (Flash Override)	The flash does not fire. (p. 36)
④	Fill-In Flash (Forced Activation)	Fires regardless of available light. (p. 37)
⑤	Landscape	To shoot distant subjects like mountains and clouds. (p. 38)
⑥	Night Scene Flash	Lights the subject in the foreground with a night scene in the background. (p. 39)
⑦	Red-eye Reducing Night Scene Flash	Significantly reduces the "red-eye" phenomenon against a night background, (p. 40)

AUTO FLASH

In this mode, the flash fires automatically when the light level is low. This mode should normally be used.

1. Press the shutter release button halfway. If the red lamp is on, the flash will fire.

Fully press the shutter release button.

Red lamp indications

- Lights: the flash will fire
Goes out: the flash will not fire
Blinks: the shutter cannot be released until the flash is fully charged.

Flash Range (negative color film)

ISO	W (Wide angle)	T (Telephoto)
200	0.6~4.1m (2ft~13.5ft)	0.6~2.4m (2ft~7.9ft)
400	0.6~5.8m (2ft~19ft)	0.6~3.4m (2ft~11.2ft)

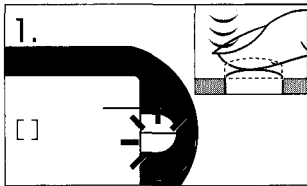

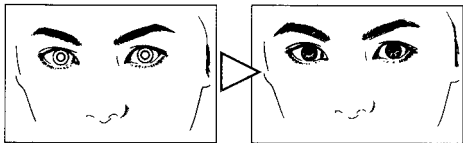

👁️ RED-EYE REDUCING FLASH

Significantly reduces the phenomenon of "red-eye" (when subject's eyes appear red in flash photography).

In the 👁️ flash mode, the camera will fire a series of more than 20 pre-flashes before the regular flash. This makes the subject's pupils contract, significantly reducing red-eye. Except for the pre-flashes, this mode is the same as the Auto Flash mode.

Red-eye reduction may not be effective when the subject:

1. Is not looking at the flash from the right front.
2. Is not watching the pre-flashes.
3. Is too far from the camera.
4. Does not respond to the pre-flashes due to particular individual characteristics.

IMPORTANT: Be sure to hold the camera still until the shutter releases. It takes approximately one second.

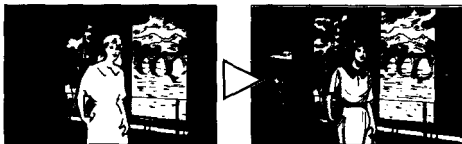

OFF(Flash Override)

Use this mode when you do not want to use the flash even in a dark place. The flash will not fire even if the light level is low. This mode can also be used in such places as museums where flash is prohibited, for night scenes, etc.

The shutter speed can be set to as slow as 1 sec. It is recommended that a tripod be used to avoid blurring due to camera shake.

Note: When the power switch is turned OFF, the camera returns to the Auto Flash mode.



⚡ FILL-IN FLASH (Forced Activation)

Use this mode when you want the flash to fire regardless of lighting conditions. The flash will always fire in this mode. This mode is useful for softening the shadows of subjects in the shade of a tree, etc., with backlit subjects, and under fluorescent and other artificial lighting.

Always make sure the subject is within the flash range (p. 34). The effect of the flash will be less evident in bright lighting.

Note: When the power switch is turned OFF, the camera returns to the Auto Flash mode.

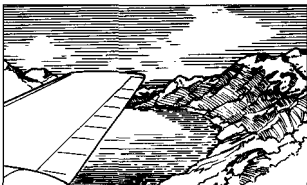

LANDSCAPE

Use this mode to shoot a landscape photograph through a window or to shoot distant subjects such as mountains or clouds.

Select the Landscape mode.
The camera automatically sets the working distance at infinity.

- The flash will not fire.
- The shutter speed can be set to as slow as 1 sec. In dark places, it is recommended that a tripod be used to avoid blurring due to camera shake.
- Moving subjects will be blurred when photographed at the slower shutter speeds.

Note: When the power is turned off and on again, the camera returns to the Auto Flash mode.

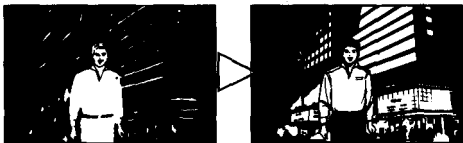

NIGHT SCENE FLASH

Use this mode to capture a night scene with or without a subject in the foreground beautifully.

Notes:

- Since a slow shutter speed (down to 1 second) is automatically selected in low-light situations, use a tripod to prevent blurred pictures caused by camera shake.
- When the power switch is turned OFF, the camera returns to the Auto Flash mode.



RED-EYE REDUCING NIGHT SCENE FLASH

Significantly reduces the "red-eye" phenomenon often seen when people are photographed against a night background.

The camera will fire a series of more than 20 pre-flashes before the flash fires. This makes the subject's pupils contract, significantly reducing the red-eye. Except for the pre-flashes, this mode is the same as the Night Scene mode.

Read the precautionary remarks in "Red-eye Reducing Flash" (p. 35) and "Night Scene Flash" (p. 39).

Note: When the power switch is turned OFF, the camera switches to the Red-eye Reducing Flash mode.

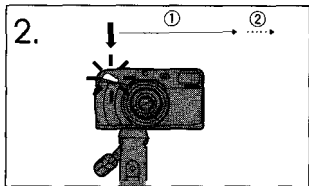
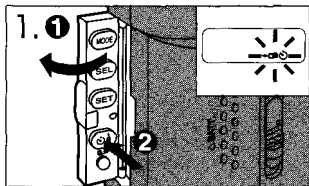

SELFTIMER

To Put Yourself in the Picture

- Open the control panel.
 - Press the  button.  will be displayed on the LCD panel.

Make sure

Use a tripod to hold the camera securely.

- Aim at your subject, and press the shutter release button.

- 10 sec.: Selftimer indicator lights
- 2 sec.: Blinks





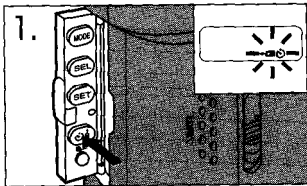

The shutter will be released approximately 12 seconds after the shutter release.

Notes:

- The focus and exposure will be locked when the shutter release button is depressed halfway.
- The selftimer is disengaged when the shutter is released.
- To cancel the selftimer after it has been activated, press the  button again.



REMOTE CONTROL (optional)

1. Press the   button.   will be displayed on the LCD panel.
After shooting, press the   button again to cancel the selftimer/remote control mode. Remote control operation is canceled automatically when not in use for more than 5 minutes.

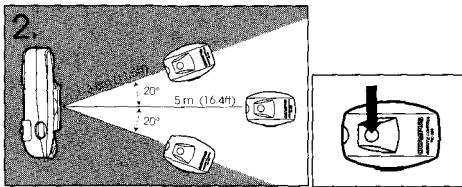

2. Aim the remote control at the camera, and press the button. The shutter will be released after about 3 seconds.

Notes:

- Use the remote control within the range shown at left.
- The camera will focus on the subject directly in front of it.
- The remote control may not work when the subject is backlit. In this case, use the selftimer.
- The remote control may not work when there is inverted fluorescent light near the camera.

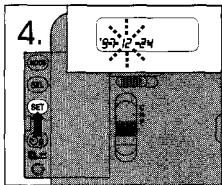
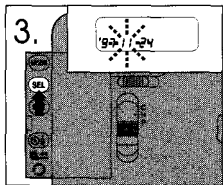
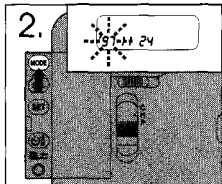
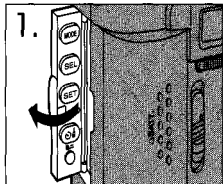

CORRECTING THE DATA

1. Open the control panel.
2. Press and hold the MODE button for at least two seconds. The year indication should start blinking at the time.
3. Press the SEL button to choose the data you want to correct. The selected data will start blinking.
Each time you press the SEL button, the blinking indicator changes in the order of year, month, day, hour, and minute.
4. Press the SET button to correct the data.
If you keep the button pressed, the numbers will run in rapid succession.

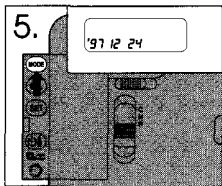

5. Press the MODE button again to complete data correction.

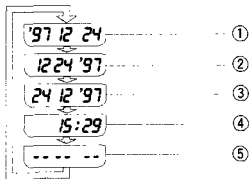
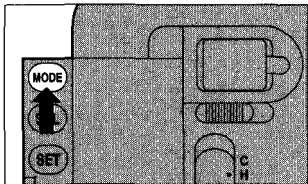

PRINTING THE DATE AND TIME

1. Open the control panel.
2. Press the MODE button to select the display to be printed.
 - ① Year/month/day
 - ② Month/day/year
 - ③ Day/month/year
 - ④ Hour/minute
 - ⑤ No printing

Each time the MODE button is pressed, the display will change in the sequence shown in the diagram on the left.

- The quartz date function uses the same power source as the main unit. Be sure to correct the data after the battery is replaced.
- The printing of dates is handled differently by different processors. For details, ask your local processor.
- Date data is recorded magnetically but is not printed on the film.
- Date data is recorded magnetically to enable printing on either the front or the back of prints.

QUESTIONS AND ANSWERS

- Q: What kind of subjects are difficult for autofocus? And what should be done in such cases?
- A: The following subjects are difficult for autofocus; therefore, use the focus lock to focus on another subject at the same distance or, when the subject is at a distance, use the Landscape mode.
1. Glossy subjects.
 2. Black objects.
 3. Scenes shot through glass or metal netting.
 4. Objects such as smoke or fire that have no substance.
 5. Scenes in which the sun appears in the picture.
- Q: When a cartridge is inserted, the motor can be heard but the film does not advance.
- A: Remove the cartridge and check the visual exposure indicator. If the visual exposure indicator is set to **O** (unexposed) re-insert the cartridge; otherwise, insert a new cartridge.
- Q: What happens if the cartridge cover is opened with a partially exposed cartridge inside?
- A: Close the cartridge cover immediately. There is possibility of the film in the cartridge being exposed and rendered useless; therefore, the film will be rewound. In such cases, insert a new cartridge.

Q: How long will the battery last?

A: Approximately 16 rolls of 25-exposure film (50% flash usage, determined under Olympus test conditions). The battery may last even longer if the flash and zoom are used infrequently.

Q: What should I do if the lens becomes dirty?

A: Use lens cleaner and lens tissue and gently wipe the lens clean.

Q: When is the exposure metered?

A: When the shutter release button is partially depressed, the exposure is metered at the same time that the focus is adjusted. Both are locked while the shutter release button is partially depressed.

Q: Does the flash become hot?

A: The flash can become hot if used continuously. At such times, stop using the camera briefly to give the flash time to cool.

Q: Can reversal film be used?

A: Yes. However, the flash range will be approximately 70% of that for negative film.

Q: Is it possible to change the print type (C, H, P type) when having copies made?

A: Yes. However, this is handled differently by different processors. For details, ask your local processor.

CARE AND STORAGE

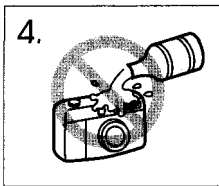
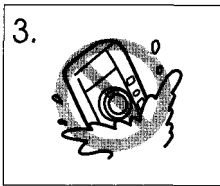
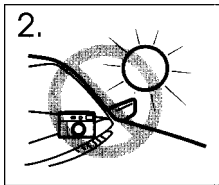
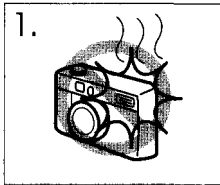

1. Do not touch the front surface of the flash after using the flash continuously in a short time as the flash may be hot.
2. Do not leave camera in any place exposed to excessive heat, humidity, or direct sunlight - for example, in a car or on the beach.
3. If the camera gets wet, wipe it with a dry towel immediately. The salt in seawater can be especially damaging.
4. Do not use organic solvents, such as alcohol or paint thinner when cleaning the camera.

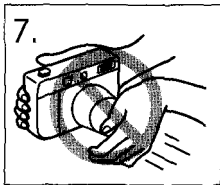
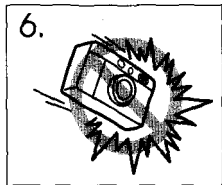
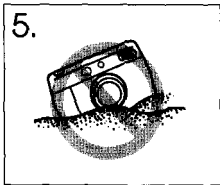

5. Do not expose the camera to dust or sand as this could cause serious damage.

6. Do not shake or shock the camera.

7. Do not apply excessive force to the lens barrel.

- Do not expose the camera to formalin or naphthalene.
- Please keep the camera in a well-ventilated place.
- Do not expose the camera to extreme heat (over 40°C/104°F) or to extreme cold (below -10°C/40°F). Low temperatures, even within this range, may sometimes cause deterioration in battery performance, temporarily disabling the camera.

- When transporting the camera from a cold place to a warm place or in the event of a sudden temperature change, put the camera into a plastic bag. This allows the camera's temperature to change slowly. Once the camera has adjusted to the new temperature, you can remove it from the bag and use it.
- Keep your hair, hands, strap etc. away from the autofocus window, lens, light sensor and flash.
- Avoid leaving the camera unused for long periods of time. This can cause mold to grow on the camera as well as other problems. Try to press the shutter release button and check the operation of camera before use.
- Some airport X-ray machines can damage the film in your camera. Try to avoid passing your camera through these machines. Give to the security officer for manual inspection.
- This camera is controlled by a microcomputer. Problems with the microcomputer can affect or stop camera operation. If this happens, remove the batteries, then reload them and try the camera again. Strong electrical fields can also interfere with the operation of this camera so try to avoid places or objects that generate such fields.
- This camera is not suitable for professional use or for use under severe conditions.

BATTERY HANDLING

- ⚠ Use the batteries correctly. Incorrect usage can result in leaking, heat and damage. When replacing the batteries, make sure the plus (+) and minus (-) terminals are correctly aligned.
- ⚠ Do not short, disassemble or charge the batteries. Never throw batteries into fire because this can result in splitting or explosion.
- ⚠ Store batteries out of the reach of children. If a battery is swallowed, consult a physician immediately.
- Battery performance will drop temporarily at lower temperatures. In cold areas, protect the camera by using protective gear or placing it inside your clothing. Even when performance drops due to low temperature, it will be restored at normal temperatures.
- Sweat or oil on the plus (+) and minus (-) terminals can cause poor contact. Wipe batteries carefully with a dry cloth before use.

- We recommend that you carry spare batteries on long trips, especially in foreign countries where availability is questionable.
- Please note that the battery supplied with the camera is for test purposes only; therefore, the service life cannot be guaranteed.
- There is danger of battery leakage when the camera is not used for an extended period; therefore, remove the battery and store in a location with low humidity and temperature of 20°C (68°F) or less.
- Always observe the cautions listed on the battery.
- Dispose of used batteries as prescribed by local regulations.

REMOTE CONTROL (optional) HANDLING

- Keep the remote control out of the reach of children. If a child swallows the remote control, contact a physician immediately.
- Never try to disassemble the remote control. Never expose the remote control to excessive heat or open flame.

TROUBLESHOOTING

OPERATING PROBLEMS

The camera does not work.

- ① The power is OFF.
→ Set the power switch to ON. (p. 21)
- ② The battery is loaded incorrectly.
→ Reload the battery correctly. (p. 15)
- ③ The battery is exhausted.
→ Replace the battery with a new one. (p. 16)
- ④ The battery performance has dropped due to cold.
→ Keep the camera warm while using it. (p. 52)
- ⑤ The cartridge has been exposed and rewound.
→ Remove the cartridge. (p. 26)
- ⑥ The cartridge is inserted incorrectly.
→ Remove the cartridge and re-insert correctly. (p. 19)

The red lamp blinks and the shutter cannot be released.

- ① The flash is not yet completely recharged.
→ Remove your finger from the shutter release button, wait several seconds until recharging is completed, and then take the picture. (p. 34)

The flash will not fire even when the light level is low.

- ① The Flash Off mode has been set.
→ Set another shooting mode. (p. 32)
- ② You are using high-speed film.
→ Set the Fill-In mode and take the picture. (p. 37)

PROBLEMS WITH PICTURES

Some pictures are out of focus.

- ① The camera moved when the shutter release button was pressed.
→ Hold the camera correctly and press the shutter release button gently. (p. 18)
- ② The subject was outside the autofocus frame.
→ Position the subject in the center of the frame or use the focus lock. (p. 24)
- ③ The lens or autofocus window was dirty.
→ Clean the lens and autofocus window. (p. 6)
- ④ A finger, etc., was in front of the autofocus window.
→ Hold the camera correctly, keeping the fingers, etc., away from the autofocus window. (p. 17)
- ⑤ The subject was closer than the minimum focusing distance of 0.6m (2ft).
→ Position the subject 0.6m (2ft) or more away from the camera and take the picture. (p. 23)

- ⑥ You stood directly in front of the camera and pressed the shutter release button when using the selftimer.
→ Press the shutter release button while looking through the viewfinder, not when standing in front of the camera.
(p. 41)

The finished prints are dark.

- ① The fingers, etc., were in front of the flash.
→ Hold the camera correctly so the flash is not covered by the fingers, etc. (p. 17)
- ② The subject was beyond the flash range.
→ Position the subject within the flash range. (p. 34)
- ③ The Flash Off mode was set.
→ Check the shooting mode and reset if necessary. (p. 36)
- ④ The picture was taken with backlighting.
→ Set the Fill-in mode and take the picture. (p. 37)

The colors in indoor pictures are not normal.

- ① The colors were affected by the color of the indoor lighting.
→ Set the Fill-In mode and take the picture. (p. 37)

SPECIFICATIONS

Type: Fully automatic, autofocus lens-shutter camera with built-in 30mm ~ 90mm zoom lens.

Film format: IX240 cartridge film.

Image size: 16.7mm x 30.2mm

Print type: Three selectable types (C, H, P) with magnetic IX (information input) function.

Lens: Olympus lens, 30mm ~ 90mm, F4.8 ~ 10.5, 8 elements in 6 groups.

Zoom drive: Step zoom system.

Shutter: Electronically controlled lens shutter.

Shutter speeds: 1/400 sec. - 1 sec.

Focusing: Active type autofocus with focus lock.

Focusing range: 0.6m (2ft) ~ infinity with Landscape mode.

Viewfinder: Real image type zoom viewfinder. C, H, P print type selection.

Magnification: 0.52X-1.43X.

Viewfinder displays: Autofocus frame, close-up correction marks, autofocus indicator and flash indicator.

Exposure control: Programmed AE, auto-flash at low light levels.

Exposure counter: Progressive type LCD panel display.

Film speed range: Automatic setting.
Automatic setting range: ISO25 ~ ISO3200.

Film loading: One-touch insertion, automatic loading (automatically advances to first frame when cartridge cover is closed).

Film advance: Automatic film winding.

Film rewind: Automatic rewind at end of roll. Mid-roll rewind also possible.

Selftimer: Electronic selftimer with approx. 12 sec. delay.

Remote control (optional): Infrared remote control unit with 3-sec. delay.

Flash: Built-in flash.

Flash recycle time: approx. 4.5 sec. (with new battery at normal temperature).

Flash range:

ISO200 negative color:







WIDE: 0.6m ~ 4.1m (2ft~13.5ft)

TELE: 0.6m ~ 2.4m (2ft~7.9ft)

ISO400 negative color:

WIDE: 0.6m ~ 5.8m (2ft~19ft)

TELE: 0.6m ~ 3.4m (2ft~11.2ft)

Shooting modes: Auto (Automatic flash activation in lowlight),  Red-eye Reducing (otherwise same as in Auto),  Flash Off (no flash),  Fill-In (forced activation),  Night Scene (for night scenes with slowest shutter speed of 1 sec. Other functions operate same as in Auto),   Red-eye Reducing Night Scene (otherwise same as in Night Scene).

Battery check: Displayed on LCD panel.

Power source: One 3V lithium battery (DL123A or CR123A).

Dimensions: 121mm (W) x 67mm (H) x 40mm (D)
(4.8 x 2.6 x 1.6 in) (excluding protrusions).

Weight: 225 grams (7.1 oz) (not including battery).

■ SPECIFICATIONS FOR DATE UNIT

Data recording method: Recording using magnetic IX (information input) function.

Data coding: Year-month-day, month-day-year, day-month-year, hour-minute and no data.

External display of recorded data:

Always displayed on LCD panel.

Automatic calendar function:

Automatic compensation to the year 2037.

Power source: ordinarily used with camera body.

SPECIFICATIONS ARE SUBJECT TO CHANGE
WITHOUT ANY NOTICE OR OBLIGATION ON THE
PART OF THE MANUFACTURER.

OLYMPUS®

OLYMPUS OPTICAL CO.,LTD.

San-Ei Building, 22-2, Nishi Shinjuku 1-chome, Shlnjuku-ku, Tokyo, Japan. Tel. 03-3340-2211

OLYMPUS AMERICA INC.

Two Corporate Center Drive, Melville, NY 11747-3157, U.S.A.Tel. 516-844-5000/1-800-622-6372

OLYMPUS OPTICAL CO.(EUROPA) GMBH.

(Premises/Goods delivery) Wendenstrasse 14-16,20097 Hamburg, Germany. Tel. 040-237730
(Letters) Postfach 10 49 08,20034 Hamburg, Germany.

OLYMPUS OPTICAL CO.(U.K.) LTD.

2-8 Honduras Street, London EC1Y0TX, United Kingdom. Tel. 0171-253-2772