

OLYMPUS®

∞ SuperZoom3500 DLX

INSTRUCTIONS

Before using your camera, read this manual carefully to ensure correct use.

CAMERA MAINTENANCE
ENTRETIEN DE L'APPAREIL
MANUTENCIÓN DE LA CÁMARA

Thank you for purchasing this Olympus camera.

- Before using your camera, read this manual carefully to ensure correct use.
- We recommend that you take test shots to get accustomed to your camera before taking important photographs.

MAIN FEATURES

- Built-in 35mm ~ 120mm 3.4X zoom lens.
- Quartz date or time imprinting.
- Weatherproof.
- Remote control (optional).
- Versatile, easy-to-use functions include spot metering, auto-zoom, night scene, infinity and continuous shooting modes, as well as various flash modes.

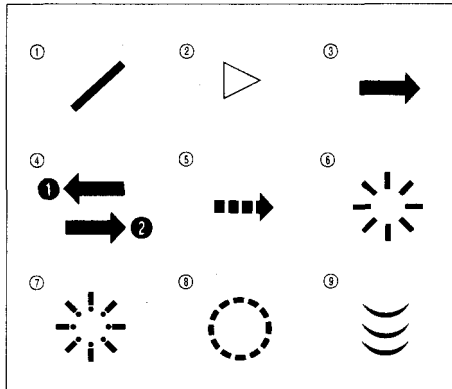

Symbols used in this manual:

- | | |
|-----------------------|----------------------|
| ① Incorrect | ⑥ Indicator on |
| ② Next operation | ⑦ Indicator blinking |
| ③ Manual operation | ⑧ Attention |
| ④ Operation order | ⑨ Depress halfway |
| ⑤ Automatic operation | |

PREPARATIONS

Names and functions of parts.....	5
Viewfinder display/LCD pane.....	6
Diopter adjustment	7
Using the strap/soft case.....	7
Outline of operations.....	8
Loading the batteries.....	10
Checking the batteries.....	11
Points to remember.....	12

BASIC OPERATIONS

Loading the film	14
Taking pictures.....	16
Unloading the film.....	20

ADVANCED TECHNIQUES

Using the flash modes.....	21
Using the subject modes.....	26
Spot.....	28
Auto-Zoom.....	30
Night Scene.....	31
Continuous Shooting.....	32
Infinity.....	33
Selftimer.....	34
Remote control (optional).....	35
Printing the date and time.....	36
Correcting the data.....	37
Lighting the LCD panel.....	38

CAMERA MAINTENANCE

Caring for your weatherproof camera.....	39
Care and storage.....	41
Battery handling	43
Remote control (optional) handling.....	44
Questions and answers.....	45
Troubleshooting.....	47
Specification.....	53

NAMES AND FUNCTIONS OF PARTS

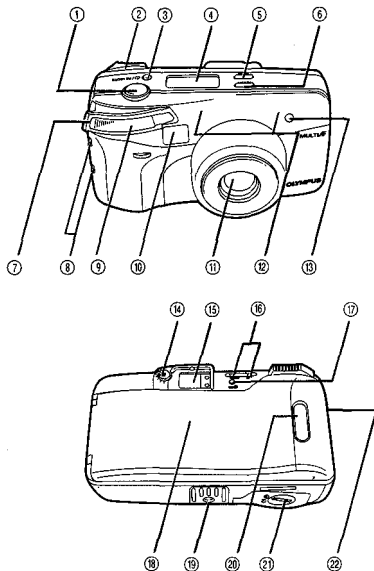

- ① Shutter release button (See p. 13.)
- ② Zoom buttons (See p. 16.)
- ③ \odot /REMOTE button (See p. 34/35.)
- ④ LCD panel (See p. 6.)
- ⑤ Subject MODE button (See p. 26.)
- ⑥ FLASH mode button (See p. 22.)
- ⑦ Power switch (See p. 11.)
- ⑧ Strap eyelet
- ⑨ Flash
- ⑩ Viewfinder
- ⑪ Lens
- ⑫ Autofocus windows
- ⑬ Selftimer indicator
- ⑭ Diopter adjustment dial (See p. 7)
- ⑮ Viewfinder (See p. 6.)
- ⑯ QUARTZDATE MODE buttons (See p.36.)
- ⑰ Mid-roll rewind button (See p. 20.)
- ⑱ Back cover
- ⑲ Tripod socket
- ⑳ Film window
- ㉑ Battery compartment cover
- ㉒ Back cover release

VIEWFINDER DISPLAY/LCD PANEL

Viewfinder Display

- ① Close-up correction marks
At a close distance, your subject must be positioned within the close-up correction marks.
- ② Orange lamp
Lights when the flash is ready to fire.
- ③ Green lamp
Lights when the subject is in focus.
- ④ Autofocus mark
Position your subject within the autofocus mark.

LCD Panel

- ⑤ Selftimer/remote control (See p. 34/35)
- ⑥ Flash modes (See p. 22.)
- ⑦ Battery check (See p. 11.)
- ⑧ Date/time indicator
- ⑨ Exposure counter (See p. 15.)
- Subject modes
- ⑩ Spot (See p. 28.)
- ⑪ Auto-zoom (See p. 30.)
- ⑫ Night Scene (See p. 31.)
- ⑬ Continuous shooting (See p. 32.)
- ⑭ Infinity (See p. 33.)

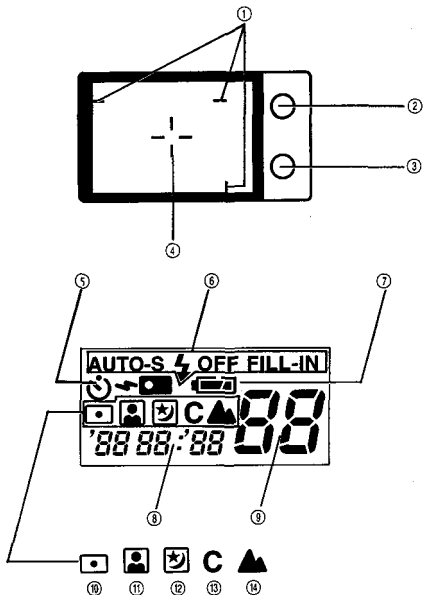

DIOPTER ADJUSTMENT

To Adjust the Viewfinder to Compensate for Near- and Farsighted Vision

Turn the diopter adjustment dial until the viewfinder display becomes clear.

Turn to the right if you are far-sighted or to the left if you are near-sighted.

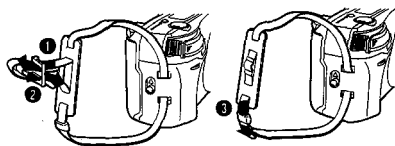
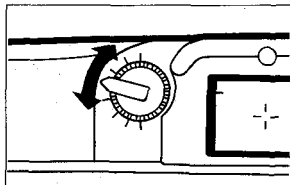

USING THE STRAP/SOFT CASE

The remote control can be stored in the pocket on the case's flap.

The soft case can also be carried on a belt.

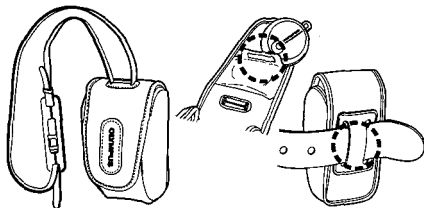

OUTLINE OF OPERATIONS Basic Shooting Procedures

1.

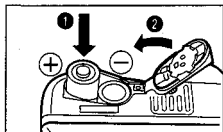

2.

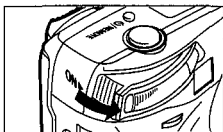

1.

Load the batteries (p. 10).

2.

Push the flash forward to turn on the power (p. 11). Practice pressing the shutter release and zoom buttons (p. 13/16).

3.

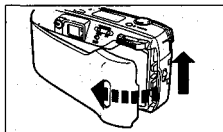

4.

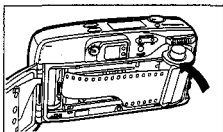

3.

Open the back cover (p. 14).

4.

Load the film (p. 14).
(Use of ISO 400 film is recommended.)

5.

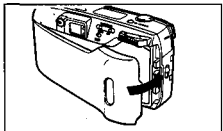

6.

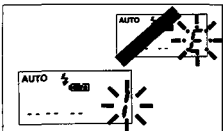

5.

Close the back cover (p. 15).

6.

Make sure the exposure counter on the LCD panel reads " ; " (p. 15).

7.

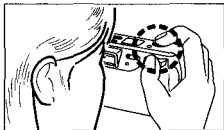

8.



7. Press the zoom button for telephoto or wide-angle photography (p. 16).

8. Place the autofocus mark on the subject you want to photograph (p. 17).

9.

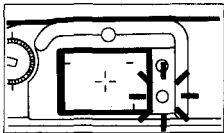

10.

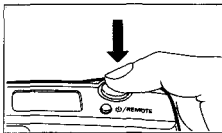

9. Depress the shutter release button halfway to make sure the green lamp lights (p. 17).

10. Depress the shutter release button fully to take a picture (p. 18).

11.

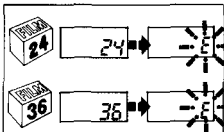

12.

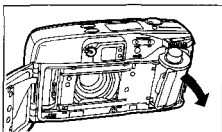

11. When the film reaches the end, it will automatically rewind (p. 20).

12. Open the back cover to remove the rewound film (p. 20).

LOADING THE BATTERIES

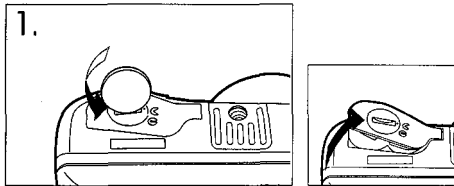

1. After switching off the power, turn the battery cover to ☞ with a coin to open the battery cover.

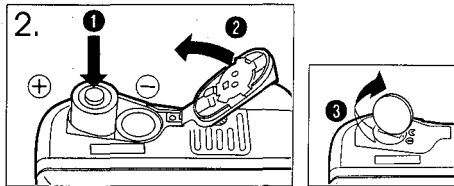



2.
 - 1 Insert two 3V lithium batteries (CR123A or DL123A).
Note: Be sure the batteries are aligned correctly as shown.
 - 2 Replace the battery cover.
 - 3 Turn the battery cover back to ☞ to lock in place.

CHECKING THE BATTERIES

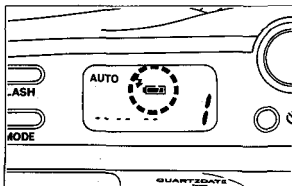
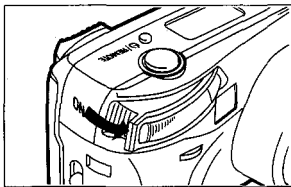
Push the flash forward to turn on the power.



Display	Meaning
 lights (and turns off automatically).	Batteries are OK. You can shoot.
 blinks and other indicators on the LCD panel are displayed normally.	Battery power is low and batteries should be replaced.
 blinks and other indicators on the LCD panel go out.	Batteries are dead and should be replaced immediately.

Note: Keep spare batteries on hand when going on a long trip or when using the camera in cold weather.

POINTS TO REMEMBER

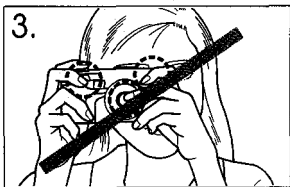
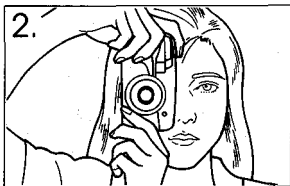
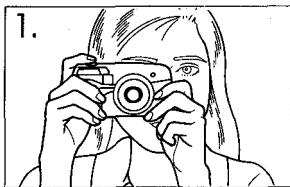

Hold the Camera Correctly.

1. Correct.
Hold the camera firmly with both hands.

2. Correct.
In the vertical position, hold the camera with its flash positioned at the top.

3. Incorrect.

Caution:

Keep your fingers and the strap away from the lens, flash, autofocus windows and viewfinder. Be sure to put the middle finger of your right hand below the protrusion next to the flash before taking a photo. When the lens and autofocus windows are stained with fingerprints, etc., wipe with a soft cloth.

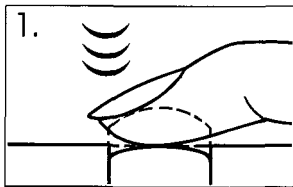

Proper Shutter Release.

Practice before loading the film.

1. Depress the shutter release button halfway to lock the focus.

Make sure

The green lamp next to the viewfinder lights.

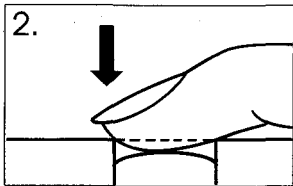

2. Depress the shutter release button fully. To release the shutter and take the picture.

Cautions:

- Press the shutter release button gently.
- Avoid shaking the camera when pressing the shutter release button to prevent blurry pictures.

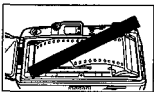
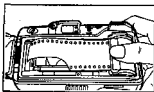
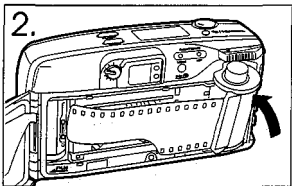
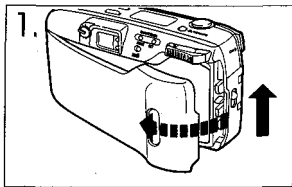

LOADING THE FILM

1. Slide the back cover release upward to open the back cover.
Do not touch the inside of the camera, especially the lens. (If the lens is dirty, see p. 45 for proper cleaning technique.)

2. Insert the film cartridge, making sure the film is lying flat.

Note: Use of ISO 400 film is recommended.

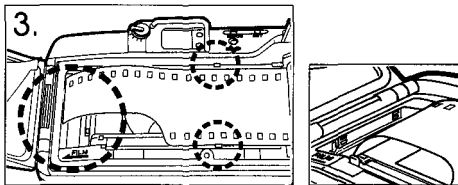

3. Align the film leader with the red mark, and close the back cover.

The film automatically advances to the first frame.

Make sure

The film does not overlap any of the positioning guides shown above.

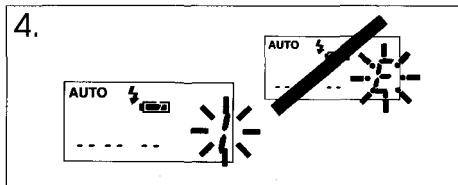

4. Push the flash forward to turn on the camera.

Make sure

The exposure counter on the LCD panel reads 1.

Note:

If \mathcal{E} blinks in the exposure counter, as shown at left, open the back cover and reload the film.

TAKING PICTURES

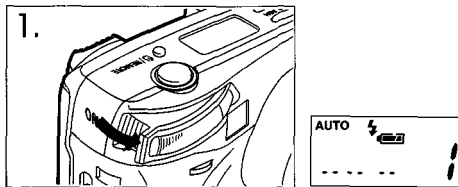

1. Push the flash forward to turn on the power.

Make sure

The lens protector opens, and the LCD panel activates.

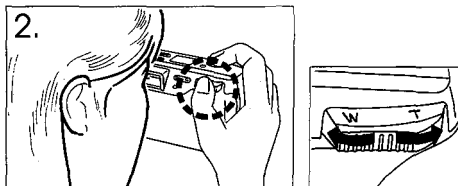

2. Aim the camera at your subject. Use the zoom button to compose your picture.

How to Use the Zoom Buttons

Telephoto: Depress the zoom button at the "T" mark.

Max. telephoto focal length: 120 mm

Wide-angle: Depress the zoom button at the "W" mark.

Max. wide-angle focal length: 35 mm

Note: There are two zoom speeds. Press the zoom button halfway for slow zooming; press fully for fast zooming.

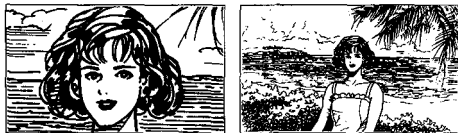



3. Position the autofocus mark on your subject.

① Autofocus mark

Focus range: 0.6 m (2 ft) ~ ∞ (infinity)

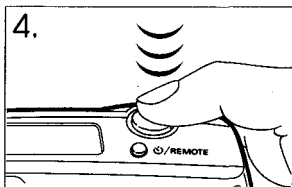

4. Depress the shutter release button halfway.

Make sure

The green lamp lights. (See p. 6.)
Once focus and exposure have been correctly adjusted, they remain locked as long as the shutter release button is kept halfway depressed.

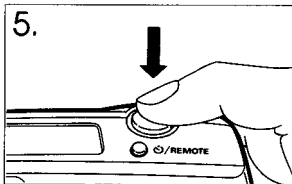

5. Depress the shutter release button fully to take the picture.

After exposure, the film automatically advances to the next frame.



This camera has a built-in multi-beam autofocus system. With this system, the camera automatically sets the focus on a subject even in compositions where the subject may not be in the center of the frame.

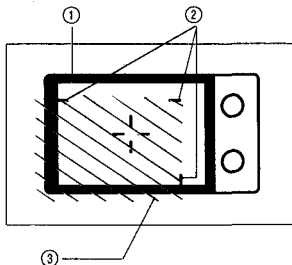

Working Distance

The focus range of the camera is 0.6 m (2 ft) to ∞ (infinity).

- When the subject is closer than 0.6 m (2 ft), the shutter will not release. (The green lamp blinks.)
- When the subject is extremely close to the camera, the subject will be out of focus although the shutter releases.

Close-up Correction

- ① Picture frame
- ② Close-up correction marks
- ③ Image area of picture at 0.75 m (2.5 ft)

The viewfinder's picture frame shows the area that can be shot for subjects at ∞ . However, the picture area will move lower in the viewfinder as you get closer to the subject. At 0.75 m (2.5 ft), the shaded area is the actual available image area. In this case, the subject should be positioned below the close-up correction marks.

UNLOADING THE FILM

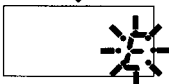
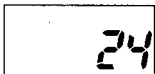
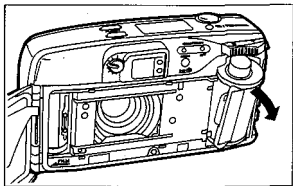

The camera automatically rewinds the film when you reach the end of a roll.

After the motor stops and "E" starts blinking on the LCD panel, open the back cover and remove the film.

Note: The final number of exposures may sometimes exceed the number of exposures specified on the film.

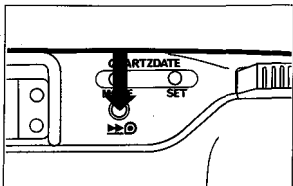

Rewinding the film before the end of the roll

Press the mid-roll button with the tip of a ballpoint pen or the like. Do not use a sharp instrument.

USING THE FLASH MODES

This camera has four flash modes. Select the flash mode according to your shooting conditions and needs.

Flash Working Range (with color negative film)

ISO	W (35mm)	T (120mm)
100	5.1 m (16.7ft)	2.8m (9.2ft)
200	7.2m (23.6 ft)	4.0m (13.1ft)
400	10.2m (33.5 ft)	5.6m (18.4ft)

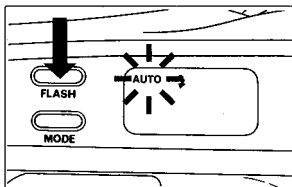

How to select the flash mode:

As you press the FLASH mode button, the mode switches as shown below. The selected flash mode is displayed on the LCD panel.

Mode	Function
AUTO	Automatically fires in low-light and backlit conditions, (p. 23)
AUTO-S	Significantly reduces the phenomenon of "red-eye" (when a subject's eyes appear red in flash photos), (p. 24)
OFF	The flash does not fire. (p. 25)
FILL-IN	Fires regardless of available light, (p. 25)

Notes:

- AUTO-S will not be canceled when the power is turned OFF. All other modes will return to the AUTO mode.
- In the Auto and Auto-S Flash modes, the flash strength is automatically controlled to prevent pictures from being overexposed even when the subjects are close.

AUTO (Auto Flash)

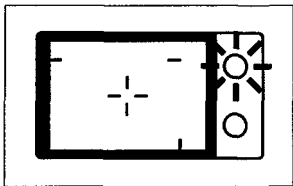

In the Auto Flash mode, the flash will fire automatically in low-light and backlit conditions.

Make sure

The orange lamp in the upper right of the viewfinder lights when the shutter release button is depressed halfway.

Notes:

- When the orange lamp is blinking, the flash is being recharged and the shutter won't release. Wait for several seconds.
- The flash sometimes does not work even in backlit conditions. (This happens especially with telephoto when the subject is too small and in other situations.) Set the flash mode to FILL-IN in such a case.

AUTO-S (Red-Eye Reducing Flash)

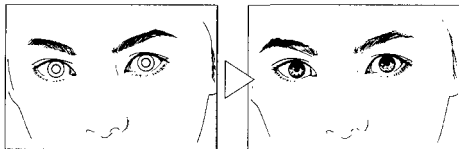

Significantly reduces the phenomenon of "red-eye" (when a subject's eyes appear red in flash photography),

In the Auto-S Flash mode, the camera will emit a series of low-power pre-flashes before the regular flash. This makes the subjects' pupils contract, significantly reducing red-eye. Except for the pre-flashes, this mode is the same as the Auto Flash mode.

Red-eye reduction may not be effective when the subject:

1. Is not looking at the flash or pre-flashes.
2. Is too far from the camera.
3. Does not respond to the pre-flashes due to particular individual characteristics.

IMPORTANT. Be sure to hold the camera still until the shutter releases.

OFF (Flash Override)

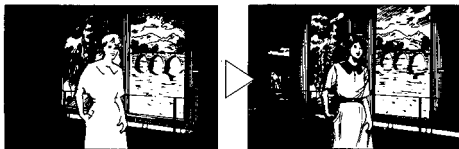

When you don't want the flash to fire even in the dark or when you want to shoot such subjects as fireworks.

In the Flash-OFF mode, the flash does not fire even in low-light conditions. Use this mode in situations where flash photography is not desired or is prohibited.

Note: Since a slow shutter speed (down to 2 seconds) is automatically selected in low-light situations when in the Flash-OFF mode, the use of a tripod is recommended to prevent blurred pictures caused by shaking the camera.

FILL-IN (Forced Activation)

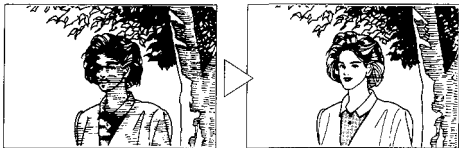

When you want to fire the flash every shot,

In the FILL-IN Flash mode, the flash fires regardless of available light. For example, this mode can be used to brighten up a subject's face that is shadowed.





USING THE SUBJECT MODES

The camera's five subject modes offer a variety of functions.

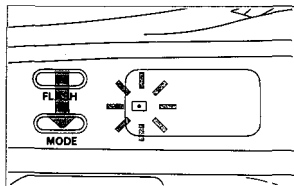
How to select the subject mode:

As you press the subject MODE button, the mode switches as shown below. The selected subject mode is displayed on the LCD panel.



Mode	Function
	Spot (p. 28) The camera can attain the focus and exposure that are set for a selected area of the scene.
	Auto-Zoom (p. 30) You can keep the subject's head and shoulders framed in the viewfinder.
	Night Scene (p. 31) You can capture a night scene beautifully.
	Continuous Shooting (p. 32) You can shoot a continuous series of pictures in rapid succession.
	Infinity (p. 33) You can shoot a landscape through a window and distant subjects like mountains and clouds.

Note: When the power is turned off and on again, the camera returns to the Normal mode.

 **SPOT**

To Attain the Focus and Exposure for a Selected Area.

In the case shown on the left, the camera will set the exposure for the background in the normal mode.

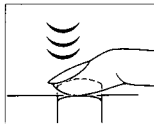
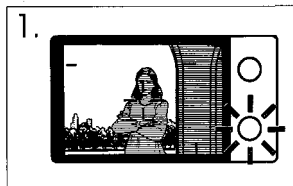
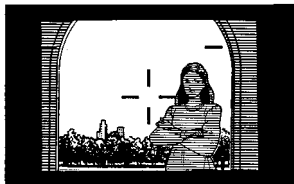

1. Using the subject MODE button, select the Spot mode. Position the autofocus mark  on your subject and press the shutter release button halfway.

Make sure

The green lamp next to the viewfinder lights.

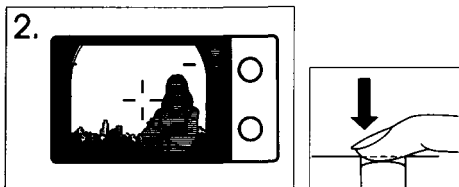

2. Reposition your subject in the picture frame while keeping the shutter release button depressed halfway.

When the shutter release button is pressed halfway, the focus and exposure will be locked in the center of the autofocus mark.

3. Depress the shutter release button fully to take the picture.

The use of the Spot mode is recommended in the following cases.

- When there is an object in front of the main subject.
- When the subject is on the edge of the frame.
- When the background is brighter than the subject (the subject is backlit).

Note: The Spot mode cannot be used in combination with the other Subject modes

AUTO-ZOOM

To Keep the Subject's Head-and-Shoulder Framed in the Viewfinder

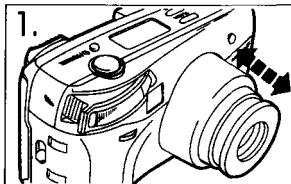

1. Using the subject MODE button, select the Auto-Zoom mode. Point your camera at the subject and press the shutter release button halfway.

The lens will automatically zoom until the frame is filled with an adult's head and shoulders.

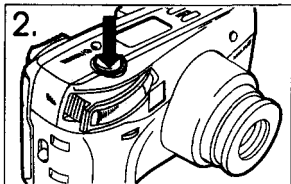

2. When the lens stops zooming, press the shutter release button fully.

Even in the Auto-Zoom mode, it is possible to use the zoom button.

Note: Outside 1.2 ~ 4.2 m (3.9 ~ 13.8 ft), the subject won't be zoomed in to the frame as specified

NIGHT SCENE

To Capture a Night Scene Beautifully

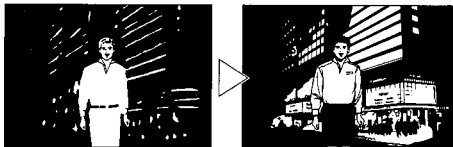

Using the subject MODE button, select the Night Scene mode.

Any flash mode can be combined with the Night Scene mode.

When in the Auto, Auto-S, or Fill-In mode:

Both the subject in the foreground and the night scene will be properly exposed.

When in the Flash-Off mode:

The night scene will be properly exposed.



Note: Since a slow shutter speed (down to 2 seconds) is automatically selected in low-light situations, the use of a tripod is recommended to prevent blurred pictures caused by shaking the camera.

C CONTINUOUS SHOOTING

To Shoot a Continuous Series of Pictures.

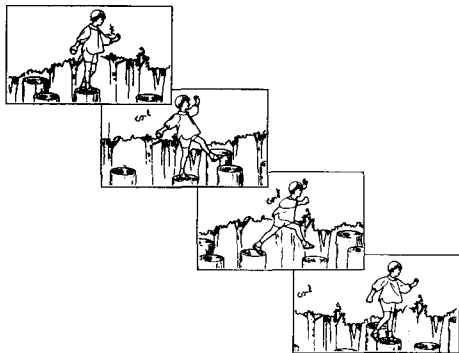

Using the subject MODE button, select the Continuous Shooting mode. Aim at the subject. Press the shutter release button.

The camera will shoot repeatedly up to 4 frames while the shutter release button is fully depressed.

Note: The focus and exposure will be fixed at the first frame.

High-Speed 4-Frame/Sec. Continuous Shooting

In the Continuous Shooting mode, as many as 4 frames/sec. can be taken.* In this case, the shutter stops being released after the fourth frame is taken, even if the shutter release button remains pressed down. (When the flash function is combined with Continuous Shooting, the shutter can be released at intervals ranging from approx. 0.5 - 4 seconds.)

• When shooting in sunlight with film of speed ISO 100 or faster.

When the film is not loaded:

In the Continuous Shooting mode, the motor operates even if film is not loaded. But to conserve battery power, the flash does not fire even in Auto or Auto-S modes.

Note: C starts blinking when there are less than 4 remaining exposures of film when DX-coded film is loaded. (See Q & A on page 90 when using non-DX-coded film.)



To Shoot a Landscape Through a Window and Distant Subjects

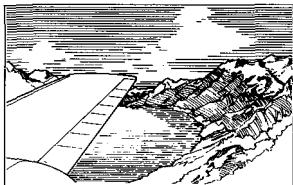

In this mode, the camera automatically sets the working distance at infinity. Engage the Infinity mode to set focus evenly throughout the frame.

Notes:

- The flash does not fire even in the Auto or Auto-S mode.
- When the shutter release button is pressed halfway, the exposure will be locked.

SELFTIMER To Put Yourself in the Picture

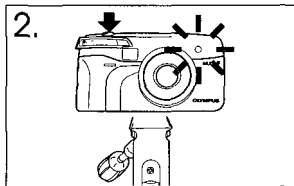
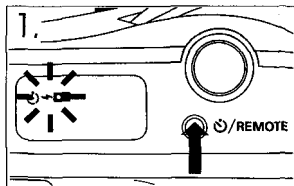

1. Press the  /REMOTE button.  is displayed on the LCD panel.

2. Aim at your subject, and press the shutter release button.

- ① 10 sec.: Selftimer indicator lights
- ② 2 sec.: Blinks

The shutter will be released 12 seconds after pressing the shutter release.

Notes:

- The focus and exposure will be locked when the shutter release button is depressed halfway.
- The Selftimer is disengaged when the shutter is released.
- To cancel the Selftimer after it has been activated press the  /REMOTE button again.
- When the Selftimer and Continuous modes are combined, the shutter releases twice at an interval of 2 sec.

REMOTE CONTROL (optional)

The optional RC-100 Remote Control is required in the operation below.

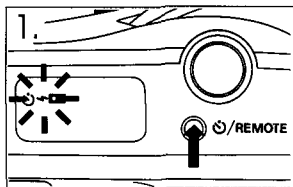

1. Press the /REMOTE button. is displayed on the LCD panel.

After shooting, press the /REMOTE button again to cancel the Remote Control mode. Remote control operation is canceled automatically when not in use for more than about 20 minutes.

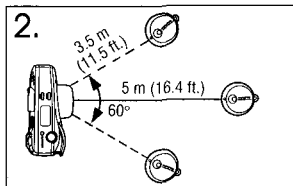

2. Aim the remote control at the camera, and press the button. The shutter will be released after 3 seconds.

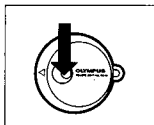

Notes:

- Use the remote control within the range shown at left.
- The camera will focus on the subject directly in front of it.
- In backlit situations, remote control shooting may sometimes be impossible.
- Only two frames can be shot successively when using the remote control in the Continuous Shooting mode.

CAUTIONS: ● KEEP THE REMOTE CONTROL OUT OF THE REACH OF CHILDREN. IF A CHILD SWALLOWS THE REMOTE CONTROL CONTACT A DOCTOR IMMEDIATELY. ● NEVER TRY TO DISASSEMBLE THE REMOTE CONTROL. NEVER EXPOSE THE REMOTE CONTROL TO EXCESSIVE HEAT OR OPEN FLAME.

PRINTING THE DATE AND TIME

Choose the desired mode with the MODE button.

The mode will switch in the described order by pressing the MODE button.

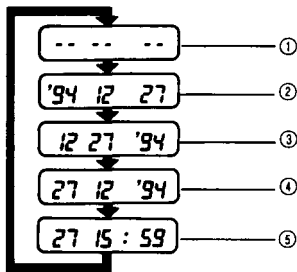
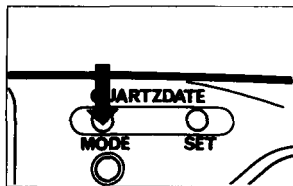

The quartz date uses the same power source as the main unit. Make sure to correct the data after the batteries are replaced.

The data is imprinted in the lower right of the picture. If there is something whitish or tinged with orange where the data is imprinted, the data may be difficult to read. The data may not be imprinted correctly on the frame(s) after the specified final exposure of the film.

- ① No data
- ② Year-month-day
- ③ Month-day-year
- ④ Day-month-year
- ⑤ Day-hour-minute

CORRECTING THE DATA

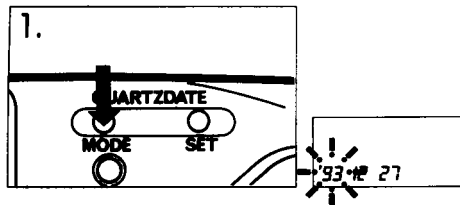

1. Press the MODE button for two seconds or longer.

The year indication will start blinking.

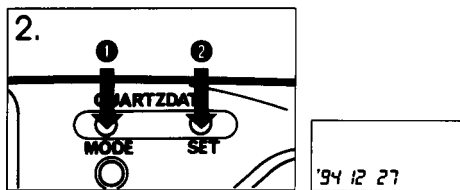

2. Press the mode button ❶ again to choose the data to be corrected until it starts blinking. And press the SET button ❷ to correct the data.

If you press the button once, the number on the display will advance by 1. And if you keep it pressed, the numbers will run in rapid succession.

Note: As you press the mode button, the blinking indication changes in the order of year, month, day, hour, and minute. The data correction will be finished when the mode button is pressed again.

LIGHTING THE LCD PANEL

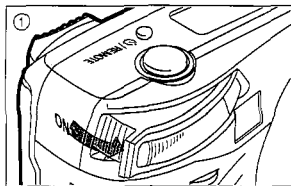

When the power is switched on in the dark ① or any of the following operations are performed while the power is on in the dark, and the camera will light the LCD panel automatically.

- ② Pressing the subject MODE button
- ③ Pressing the FLASH mode button
- ④ Pressing the shutter release button halfway
- ⑤ Pressing the  /REMOTE button
- ⑥ Pressing the QUARTZDATE MODE or QUARTZDATE SET button

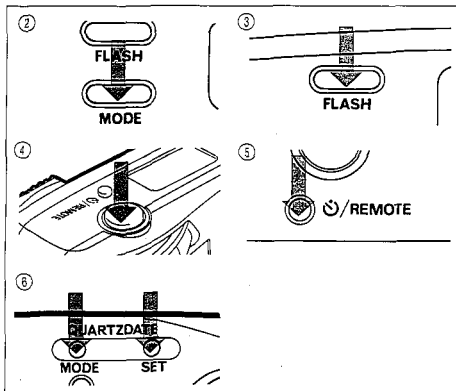

The light will go out automatically after approximately 30 seconds. If any of the above operations is performed while the light is on, illumination duration will be extended.

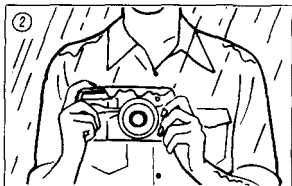
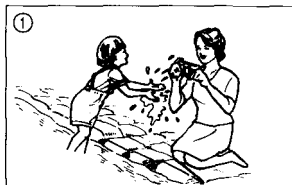

CARING FOR YOUR WEATHERPROOF CAMERA

This camera is weatherproof; however, it is not designed for underwater use. Please note the following warnings and use the camera correctly.

- ① The camera can withstand splashing water (e.g., seaside, swimming pool side, etc.)
- ② The camera can be used in rain.
- ③ And in snow.

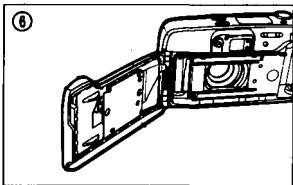
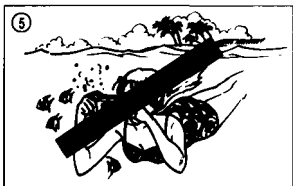
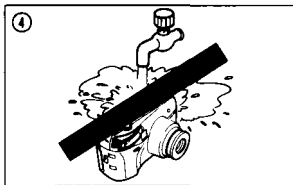

- ④ Do not wash the camera.
 - ⑤ Do not submerge the camera or attempt to take pictures underwater.
 - ⑥ Rubber gaskets are located inside the rear of the camera. Check the gaskets for wear and carefully remove any sand and dust to maintain a weatherproof seal.
- If the camera has been splashed by water, etc., clean the camera with a dry cloth as soon as possible.
 - Do not touch the rubber gasket on the battery compartment cover or the rubber gasket on the camera back with excessive force. Do not remove the gaskets.
 - Gaskets should be replaced after approximately three years, although they may require replacement earlier than that depending on use and wear.
 - If the gaskets are damaged or need replacement, contact your nearest Olympus service center.

CARE AND STORAGE

CAUTIONS

- DO NOT EXPOSE THE CAMERA TO EXTREME HEAT (OVER 40°C/104°F) OR TO EXTREME COLD (BELOW -10°C/14°F).
- AVOID SUDDEN TEMPERATURE CHANGES AND HUMIDITY.
- DO NOT EXPOSE THE CAMERA TO STRONG MAGNETIC FIELDS.
- DO NOT APPLY EXCESSIVE FORCE TO THE CAMERA OR ITS CONTROLS.
- DO NOT TOUCH THE CONTACT POINTS INSIDE THE CAMERA.
- DO NOT USE ORGANIC SOLVENTS, THINNERS, OR BENZINE TO CLEAN THE CAMERA.
- AVOID STRONG IMPACT CAUSED BY BUMPING OR DROPPING THE CAMERA.
- DO NOT IMMERSE THE CAMERA IN WATER.
- DO NOT EXPOSE THE CAMERA TO EXCESSIVE DUST AND SAND.
- DO NOT EXPOSE THE CAMERA TO THE COLD WHEN IT'S WET, OR THE LENS PROTECTOR, ETC. MAY FREEZE, MAKING THE CAMERA INOPERABLE.

- THE LENS BARREL IS FINISHED WITH A SPECIAL COATING TO SMOOTH THE ZOOMING MOVEMENT. NEVER WIPE IT WITH SOLVENTS LIKE THINNERS OR BENZINE. WHEN IT IS HEAVILY STAINED, CLEAN IT WITH A MOISTENED CLOTH AND THEN WIPE OFF THE MOISTURE WITH A DRY CLOTH.

WARNING

- NEVER ATTEMPT TO DISASSEMBLE THE CAMERA; IT CONTAINS A HIGH-VOLTAGE CIRCUIT.

In case of malfunction, consult your nearest Olympus dealer or Olympus service center.

BATTERY HANDLING

NOTES

- Even when batteries are brand-new, their service life may be shorter than specified if an extended period of time has passed since they were produced.
- Do not mix different types of batteries or new and old batteries.
- Keep spare batteries on hand when going on a long trip or to a cold area.
- Sweat and oil can prevent a battery's terminals from making electrical contact. To avoid this, wipe both terminals before loading batteries.

WARNINGS

- NEVER TRY TO DISASSEMBLE, RECHARGE, OR SHORT CIRCUIT BATTERIES. NEVER EXPOSE BATTERIES TO EXCESSIVE HEAT.
- KEEP THE BATTERIES OUT OF THE REACH OF CHILDREN. IF A CHILD SWALLOWS A BATTERY, CONTACT A DOCTOR IMMEDIATELY.
- USE TWO 3V LITHIUM BATTERIES (CR123A OR DL123A). NEVER TRY TO DISASSEMBLE OR MODIFY ANY BATTERY OR BATTERY PACK FOR USE IN THIS CAMERA.

REMOTE CONTROL (optional) HANDLING

- The battery of the remote control cannot be replaced. The remote control unit is expendable. Order a new one from your nearby camera store or Olympus service center when it no longer transmits signals to the camera.
- Keep the remote control out of the reach of children. If a child swallows the remote control, contact a physician immediately.
- Never try to disassemble the remote control. Never expose the remote control to excessive heat or open flame.

QUESTIONS AND ANSWERS

Q: How long will the batteries last?

A: If you use 24-exposure rolls of film and use the flash for half of all your pictures, two new 3V lithium batteries (DL123A/CR123A) will last for about 25 rolls of film.

Q: How should I clean the lens?

A: Use a blower to blow away the dust. Then wipe the lens gently with a soft, clean cotton cloth that has been moistened with a small amount of lens cleaning fluid.

Q: Can I use film that is not DX-coded?

A: Yes, but only ISO 100 film.

Q: Why did my camera suddenly retract its lens while I was shooting?

A: Because you applied too much pressure to the tip of the lens. To ensure optimal performance, hold the camera so as to avoid applying any pressure to the tip of the lens.

Q:Why did my camera generate heat?

A:Because you used the flash several times in succession. If your camera gets hot, allow some time before you use it again.

Q:Can the battery in the optional remote control be replaced with a new one?

A:No, it cannot be replaced but lasts about 5 years.

Q:Can I use infrared film?

A:No. you can't.

Q:Can I mount a filter onto the lens?

A:No. The lens doesn't have a mounting thread due to its construction with a built-in protector.

Q:What happens when the Continuous Shooting mode is engaged with non-DX-coded film loaded?

A: You can use the mode, but sometimes **C** blinks no matter how many remaining exposures the film has. When this happens, the winding speed will be a bit slower.

TROUBLESHOOTING

The camera does not work.

- ① The power is off.
→ Push the flash forward to turn on the camera, (p. 16)
- ② The alignment of the battery terminals is not correct.
→ Reload the batteries correctly, (p. 10)
- ③ The batteries are exhausted.
→ Replace the batteries with new ones. (p. 11)
- ④ The batteries are temporarily unable to function due to low temperature.
→ Keep the camera warm while using it.
- ⑤ The loaded film has been rewound.
→ Load new film. (p. 20)
- ⑥ The film is incorrectly loaded.
→ Reload the film. (p. 15)

The LCD display turns off suddenly.

- ① The LCD display turns off after approx. 20 minutes if the camera is not used.
→ Turn the power off and then on again or press the shutter release button halfway to turn on the LCD panel. When the camera is not in use, keep the power OFF as much as possible.

The shutter doesn't release when the remote control's shutter release button is pressed.

- ① The remote control hasn't been used in the 20 minutes since the Selftimer/Remote Control mode was entered, causing the LCD panel to turn off.
→ Operate any button. The LCD will light. Then press the  /REMOTE button again, (p. 35)

The green lamp blinks, and the shutter will not release.

- ① The camera is closer than 0.6 m (2 ft) to the subject.
→ Move the camera farther than 0.6 m (2 ft) from the subject. (p. 19)

The orange lamp blinks, and the shutter will not release.

- ① The flash has not been recharged yet.
→ Remove your finger from the shutter release button and wait for several seconds until the flash is recharged before shooting, (p. 23)

The flash does not fire, even in the dark.

- ① The flash mode is set to OFF.
→ Set it to a mode other than OFF. (p. 21/25)
- ② The camera is in the Infinity mode which overrides the flash.
→ Cancel the Infinity mode. (p. 26/33)
- ③ High-speed film is used.
→ Set the flash mode to FILL-IN, (p. 21/25)

The picture is out of focus.

- ① The camera moved when the shutter release button was pressed.
→ Hold the camera correctly and press the shutter release button gently, (p. 12)
- ② The subject was not within the viewfinder's autofocus mark.
→ Position the subject in the center of the autofocus mark, or use the Spot mode. (p. 28)
- ③ The lens and autofocus windows were dirty.
→ Clean the lens and autofocus windows.

- ④ The autofocus window was blocked, such as by a finger.
→ Hold the camera correctly, keeping your fingers clear of the autofocus windows. (p. 12)
- ⑤ The subject was closer than the minimum working distance to the lens (0.6 m/2 ft).
→ Shoot from more than 0.6 m (2 ft) away from the subject. (p. 19)
- ⑥ While using the Selftimer, the shutter release button was pressed while standing right in front of the camera.
→ Do not stand in front of the camera. Press the shutter release button while looking through the viewfinder. (p. 34)
- ⑦ The Infinity mode is engaged.
→ Cancel the Infinity mode. (p. 33)

- ⑧ The autofocus didn't work correctly. There are some subjects that are difficult for the autofocus to lock on, which include: glossy or reflective surfaces, black objects, subjects behind glass or wire mesh, flames and smoke, excessively bright light within the picture area.
- Shoot distant subjects in the Infinity mode. When the subject is near, first focus on an object at the same distance as the desired subject in the Spot mode. Then aim at the desired subject and release the shutter. (p. 28/33)

The picture is too dark.

- ① The flash was blocked, such as by a finger.
→ Hold the camera correctly, keeping your fingers clear of the flash. (p. 12)
- ② The subject was out of the working range of the flash.
→ Shoot within the flash working range.(p. 21)
- ③ The flash mode was set to OFF.
→ Check the flash mode before shooting. (p. 22)
- ④ The subject was backlit.
→ Set the flash mode to FILL-IN. (p. 22/25)

The date has not been printed (or looks faded).

- ① The date mode was set to no data (- - -).
→ Change the date mode to another setting. (p. 36)
- ② There is a bright color like white, orange, yellow, or red in the area of the picture where the date is printed.
→ Avoid bright colors in the lower right corner of your photo compositions.
- ③ The picture was taken with black-and-white film.
→ Do not use black-and-white film if you want to print the date.

The colors of the picture taken indoors look strange.

- ① The room's illumination affected the colors.
→ Set the flash mode to FILL-IN, (p. 22/25)

SPECIFICATIONS

- Type: Fully automatic 35mm autofocus lens-shutter camera with built-in 35 ~120mm zoom lens.
- Film format: 35mm standard DX-coded film (24 X 36 mm)
- Lens: Olympus lens 35~120mm F4.5-8.7, 10 elements in 8 groups.
- Shutter: Programmed electronic shutter.
- Viewfinder: Real image type zoom viewfinder (with autofocus mark, close-up correction marks, autofocus indicator and flash indicator).
- Focusing: Active-type multi-beam autofocus system. Focus lock possible. Focusing range: 0.6 m (2 ft) ~ ∞ (infinity).
- Exposure control: Programmed automatic exposure control, center-weighted light metering, switchable to spot metering. Auto exposure range: Wide-angle — EV3.3 (F4.5, 2 sec.) to EV16 (F11, 1/500 sec.), Telephoto — EV5.2 (F8.7, 2 sec.) to EV18.6 (F27, 1/500 sec.).
- Exposure counter: Progressive type with automatic reset, displayed on LCD panel.
- Selftimer: Electronic Selftimer 12-sec. delay.

- Remote control (optional): Infrared remote control unit with 3-sec. delay.
- Film speed range: Automatic setting with DX-coded film with ISO 50, 100, 200, 400, 800, 1600, 3200. For non-DX-coded film and film speeds lower than ISO 50, film speed is set to ISO 100.
- Film loading: Automatic loading. (Automatically advances to first frame when camera back is closed).
- Film advance: Automatic film winding.
- Film rewind: Automatic film rewind (automatic rewind activation at end of film, automatic rewind stop). Rewind possible at any point with rewind button.
- Flash: Built-in flash. Recycling time: Approx. 0.2 ~ 3,5 sec. (at normal temperature with new batteries). Flash working range: Wide-angle — 0.6 ~ 5.1 m (2.0 ~ 16.7 ft), Telephoto — 0.6 ~ 2.8 m (2.0 ~ 9.2 ft) with ISO 100 color negative film; Wide-angle — 0.6 ~ 10.2 m (2.0 ~ 33.5 ft), Telephoto — 0.6 ~ 5.6 m (2.0 ~ 18.4 ft) with ISO 400 color negative film. Slow-Synchro: possible with longest shutter speed of 2 sec.

Flash modes: AUTO (Automatic flash activation in low-light and backlight). AUTO-S (Red-eye reducing, in low-light and backlight). OFF (No flash). FILL-IN (Forced activation).

External indication: LCD panel with illumination.

Battery check: Displayed on LCD panel.

Weatherproof: EC Standard publication 529.

Classification of degrees of protection provided by enclosures. Degrees of protection indicated by second characteristic numeral 4 ● Short

description: Protected against splashing water

● Definition: Water splashed against enclosure from any direction shall have no harmful effect

● Test for second numeral 4: Equipment is sprayed from all practical directions.

Power source: Two 3V lithium batteries (DL123A/CR123A).

Dimensions: 130(W) X 68(H) X 61 (D) mm (5.1 X 2.7 X 2.4 in) (without protrusions).

Weight: 315 g (11.1 oz) (without batteries).

SPECIFICATIONS FOR DATE UNIT

Imprinting direction: Data imprinted onto film from [lens side.

Data coding: No data, year-month-day, month-day-year, day-month-year and day-hour-minute.

External indication of data: Data display on liquid crystal panel.

Film speed setting: Automatic film speed setting.

Automatic calendar system: Up to year 2030.

Power source: Ordinarily used with camera body.

OLYMPUS

OLYMPUS OPTICAL CO., LTD.

San-Ei Building, 22-2, Nishi Shinjuku 1-chome, Shinjuku-ku, Tokyo, Japan. Tel. 03-3340-2211

OLYMPUS AMERICA INC.

Two Corporate Center Drive, Melville, NY 11747-3157, U.S.A. Tel. 516-844-5000

OLYMPUS OPTICAL CO. (EUROPA) GMBH.

(Premises/Goods delivery) Wendenstrasse 14-16, 20097 Hamburg, Germany. Tel. 040-237730

(Letters) Postfach 10 49 08, 20034 Hamburg, Germany.

OLYMPUS OPTICAL CO. (UK.) LTD.

2-8 Honduras Street, London EC1Y 0TX, United Kingdom. Tel. 0171-253-2772