

VECTIS 200



E Instruction Manual

Thank you for your purchase of a Minolta product. Your new camera is an easy to operate lens shutter camera from Minolta's line of Advanced Photo System™ cameras. Your new light-weight, compact camera features title imprinting, film-chamber lock, and a 25-50mm zoom lens. This manual has been designed to help you understand the operation of your camera and its functions. Please familiarize yourself with the names of the controls and their locations on the camera, then read this manual thoroughly.

Advantages of the Advanced Photo System

Easier to load...

Advanced Photo System cameras use the new IX240 type film. This new film features drop-in-loading to make loading your camera simple, the first time, every time. Indicators on the cassette tell you and your camera if the film is unexposed, partially exposed, exposed, or processed.

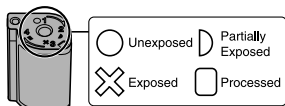

New print formats...

Classic C print, wider H print, and panorama P print formats are available with Advanced Photo System cameras.

New processing...

In addition to returning your prints in the format you selected, certified photofinishers will return your Advanced Photo System film in its original cassette with an index print. To order reprints, simply choose the images you want from the index print. No more searching through negatives to find the right frame.

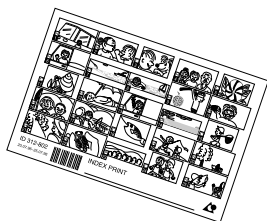

Advanced Photo System™ is a trademark of the five system developing companies.

FOR PROPER AND SAFE USE

Read and understand all warnings and cautions before using this product.

⚠ WARNING

Batteries may become hot or explode due to improper use.

- Use only the batteries specified in this instruction manual.
- Do not install the batteries with the polarity (+/-) reversed.
- Do not subject batteries to fire or high temperatures.
- Do not attempt to recharge, short, or disassemble.
- Tape over lithium battery contacts before disposal. Follow local codes for battery disposal.

Use caution, accidents may occur when using this product near young children.

Keep batteries or things that could be swallowed away from young children. Contact a doctor immediately if an object is swallowed.

Immediately remove the batteries and discontinue use if...

- the camera is dropped or subjected to an impact in which the interior is exposed.
- the product emits a strange smell, heat, or smoke.

The lens retracts when the camera is turned off or Auto Power Off is activated. Touching the lens barrel while it is retracting may cause injury.

Do not disassemble. Electric shock may occur if a high voltage circuit inside the camera is touched. Take your camera to a Minolta Service Facility when repairs are required.

OPERATING TEMPERATURE AND CONDITIONS

- This camera is designed for use for -10 to 40°C (14 to 104°F).
- Never leave your camera where it may be subjected to extreme temperatures such as the glove compartment of a car.
- At colder temperatures, the data panel response time will be slow; at higher temperatures, the display will temporarily darken, but will restore when the temperature normalizes.
- Never subject your camera to extreme humidity.
- To prevent condensation from forming, place the camera in a sealed plastic bag when bringing it from the cold exterior to a warm building. Allow it to come to room temperature before removing it from the bag.
- When photographing in cold weather, we recommend that you keep the camera and spare batteries inside your coat to keep them warm when you are not shooting. Cold batteries will regain some of their charge when they warm up.
- This camera is not waterproof, dust-proof, or sand-proof; take care when using it at the beach or near water. Costly or irreparable damage may occur.

Minolta Co., Ltd.

3-13, 2-Chome, Azuchi-Machi, Chuo-Ku, Osaka 541-8556, Japan

Minolta GmbH
 Minolta France S.A.
 Minolta (UK) Limited
 Minolta Austria Ges. m.b.H.
 Minolta Camera Benelux B.V.
 Belgium Branch
 Minolta (Schweiz) AG
 Minolta Svenska AB
 Finland Branch
 Minolta Portugal Limitada
 Minolta Corporation
 Head Office
 Los Angeles Branch
 Minolta Canada Inc.
 Head Office
 Vancouver Branch
 Minolta Hong Kong Limited
 Minolta Singapore (Pte) Ltd.
 Shanghai Minolta Optical
 Products Co., Ltd.

Kurt-Fischer-Strasse 50, D-22923 Ahrensburg, Germany
 365 Route de Saint-Germain, F-78420 Carrières-Sur-Seine, France
 Rooksley Park, Precedent Drive, Rooksley, Milton Keynes, MK13 8HF, England
 Amalienstrasse 59-61, A-1131 Wien, Austria
 Zonnebaan 39, P.O. Box 6000, NL-3600 HA Maarssen, The Netherlands
 Kontichsesteenweg 38, B-2630 Aartselaar, Belgium
 Riedstrasse 6, CH-8953 Dietikon, Switzerland
 P.O.Box 9058, Albygatan 114, S-17109 Solna, Sweden
 Niitykatu 6 PL 37, SF-02201 Espoo, Finland
 Av. do Brasil 33-A, P-1700 Lisboa, Portugal
 101 Williams Drive, Ramsey, New Jersey 07446, U.S.A.
 11150 Hope Street Cypress, CA 90630, U.S.A.
 369 Britannia Road East, Mississauga, Ontario L4Z 2H5, Canada
 230-3771 Jacobs Road, Richmond, B.C. V6V 2L9, Canada
 Room 208, 2/F, Eastern Center, 1065 King's Road, Quarry Bay, Hong Kong, China
 10, Teban Gardens Crescent, Singapore 608923

9222-2211-31 W-B801

©1997 Minolta Co., Ltd. under the Berne Convention and Universal Copyright Convention

Printed in China

NAMES OF PARTS

1. Shutter-release button
2. Title button
3. Date button
4. Data panel
5. Self-timer/Select button
6. Flash-mode/Adjust button
7. Manual-rewind button
8. Flash*
9. Viewfinder window*
10. Lens*
11. Meter window*
12. AF windows*
13. Front cover
14. Self-timer/Red-eye reduction lamp

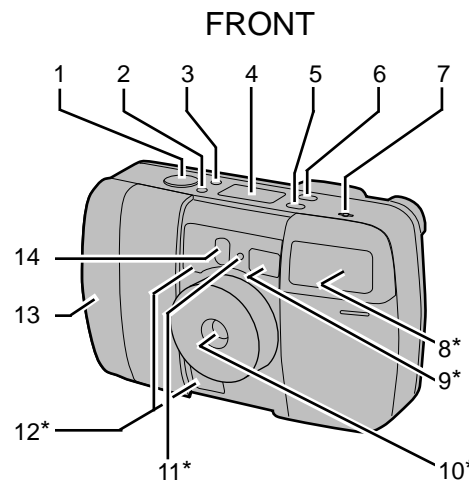

*Do not touch

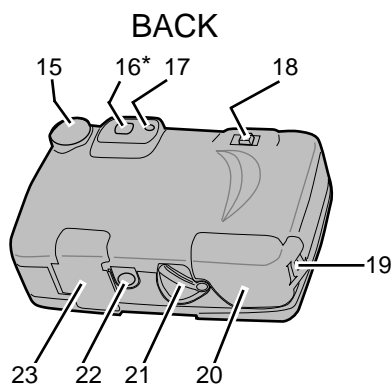

15. Format switch
16. Viewfinder*
17. Ready lamp
18. Zoom lever
19. Strap eyelet
20. Film-chamber door
21. Film-chamber release
22. Tripod socket
23. Battery-chamber door

*Do not touch

DATA PANEL

1. Title/Date/Time/ISO display
2. Title marks
3. Battery-condition indicator
4. Frame counter
5. Self-timer indicator
6. Cassette mark
7. Flash-mode indicators

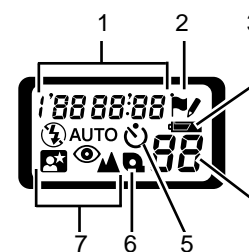

VIEWFINDER

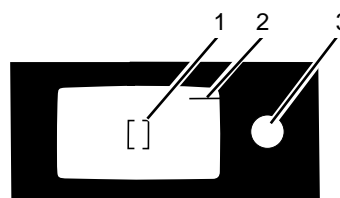

1. Focus frame
2. Close-framing guide
3. Ready lamp

Ready lamp with the shutter-release button pressed half-way down.

- | | |
|-----------------|----------------------|
| Glow: | Camera is ready |
| Blinks quickly: | Subject is too close |
| Blinks slowly: | Camera-shake warning |
| Off: | Flash is charging |

Step 1

ATTACHING THE STRAP

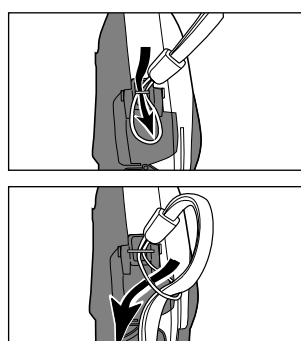

Attach the strap as shown.

Step 2

INSERTING THE BATTERY

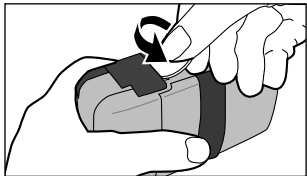

Your camera uses one 3-volt CR2 lithium battery to supply power for all camera operations.

1. Open the battery-chamber door using a coin or similar object.
2. Insert the battery according to the + and - marks inside the battery chamber and snap the cover closed.
 - After installing a new battery, reset the date and time.

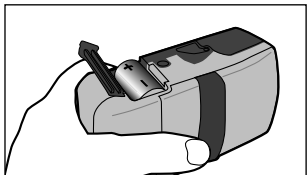

CHECKING THE BATTERY POWER

Each time the camera is turned on, a symbol will appear briefly in the data panel to indicate the power status of the battery.



Power is sufficient for all camera operations.



Power is sufficient, but the battery will have to be replaced soon.



Replace the battery. The shutter will lock until the battery is replaced.

- If no display appears, replace the battery or check that it is inserted correctly.
- To save power, your camera will shut down and retract the lens if it is not operated for more than eight minutes. Close, then open the front cover again to restore power.

Step 3

LOADING THE FILM

Your camera uses IX240 type film designed for use in Advanced Photo System cameras.

- Your camera's automatic transport system loads the film, sets the film speed, and advances the film after each exposure.
- After loading, the film chamber cannot be opened until rewind has been initiated.
- DEP, Double Exposure Prevention, prevents the camera from accepting exposed film.
- This camera will only load film with the ● mark current.

Visual Exposure Indicators

- The current VEI has a white indicator behind it.

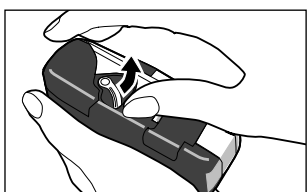
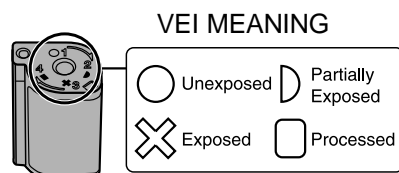

1. Turn the camera upside down and push the film-chamber release in the direction indicated.
 - The film-chamber door will open partway.

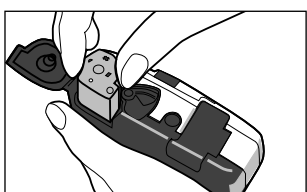

2. Insert the cassette into the film chamber.

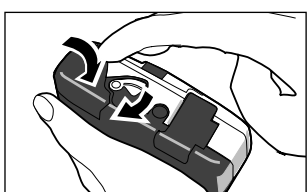

3. Press the film-chamber door closed until it clicks.
 - The camera will automatically advance the film to the first frame.

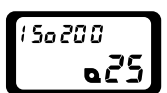

- The ISO (film speed) and number of frames remaining on the roll will be displayed in the data panel.
- Film can be loaded when the camera is on or off.
- If film is loaded with the camera off, all indicators in the data panel will disappear after the number of frames remaining is displayed.
- Do not load film without an operational battery in the camera.

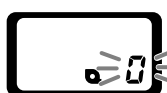

- If blinks in the data panel, open the chamber, then remove the film.
- Your camera cannot load a cassette if the current VEI is , , or .
 - If a processed (VEI) or partially exposed (VEI) cassette was loaded into this camera, the VEI has been changed to .
 - If all indicators blink in the data panel, remove and reload the film. If the film will not load, contact the nearest authorized Minolta Service Facility.

Step 4

FULL AUTO OPERATION

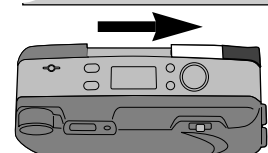

1. Open the front cover to turn the camera on.
 - The flash is set to autoflash and will fire when necessary.

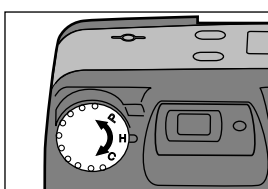

2. Select the print format. The viewfinder will change to match your selection.

FULL AUTO OPERATION-CONTINUED

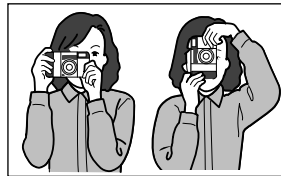

Hold the camera steady, making sure your fingers do not cover the flash. If you are taking a vertically framed picture, turn the camera so the flash is on top.

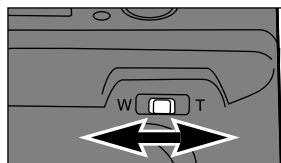

3. Looking through the viewfinder, frame the subject as desired.
 - Push the zoom lever toward W to zoom out.
 - Push the zoom lever toward T to zoom in.
 - Do not obstruct the lens barrel during movement.



4. Center your subject in the focus frame, then press the shutter-release button partway down.

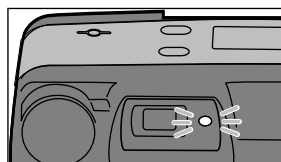

5. When the green ready lamp glows, press the shutter-release button all-the-way down to take the picture.
 - Press the shutter-release button with a slow, steady squeeze, never a quick jab.

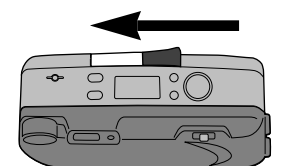

6. Turn the camera off after use by sliding the front cover closed.

FOCUS LOCK

If your subject is located outside the focus frame, you can first lock focus on your subject, then recompose the picture as desired.



1. Align the subject within the focus frame and press the shutter-release button partway down until the ready lamp glows.

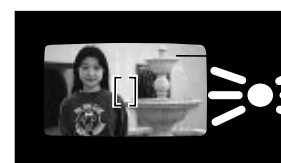

2. Without lifting your finger, recompose the picture then press the shutter-release button all the way down to take the picture.

FOR CLOSER SUBJECTS

When your subject is closer than 1.0m/3.28ft., align the top of your image with the close-framing guide, using focus hold if necessary.

- The close-framing guide is not visible in P format.

The ready lamp will blink rapidly and the shutter will lock when you are closer than the focus distance indicated below.

Focal Length	Wide	Telephoto	
Print Format	All	C or H	P
Focus Distance	0.5m - (1.64ft. -)	0.5m - (1.64ft. -)	1.0m - (3.28ft. -)

Step 5

REWINDING THE FILM

Your camera automatically rewinds the film into the cassette after the last exposure.

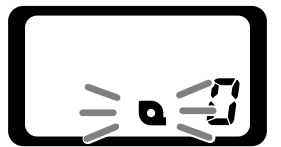

1. Wait for the film to completely rewind into the cassette.
 - The frame counter will count down during rewind.
 - will appear in the frame counter and will blink when the film is rewind.

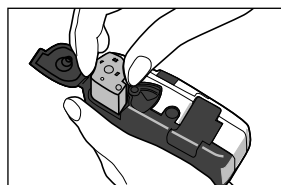

2. Turn the camera upside down and push the film-chamber release in the direction indicated.
3. Remove the cassette.
 - The film's VEI indicator will be .
 - Do not open the film chamber until the motor stops and appears and blinks in the data panel.

MANUAL REWIND

Use manual rewind to rewind the film before the roll is finished.

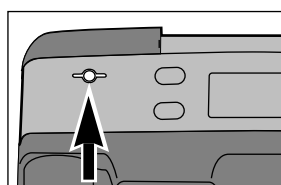

1. Gently press the manual rewind button.
2. Follow steps 1- 3 from automatic rewind.



USING THE BUILT-IN FLASH

When you turn the camera on, autoflash or autoflash with red-eye reduction is set (whichever was last used) so the flash will fire automatically in low-light situations.

FLASH RANGE

The range of the built-in flash depends on the film speed and the focal length you are using. To ensure proper exposure, make sure your subject is positioned within the flash range.

Focal Length	ISO 100	ISO 200	ISO400
Wide	0.5 - 3.0 m	0.5 - 5.0 m	0.5 - 7.1 m
	1.64 - 9.84 ft	1.64 - 16.4ft	1.64 - 23.29 ft
Telephoto	0.5 - 1.9 m	0.5 - 2.7 m	0.5 - 3.8 m
	1.64 - 6.23 ft	1.64 - 8.85 ft	1.64 - 12.46 ft.

SELECTING THE FLASH MODE

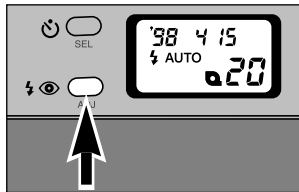

The following flash modes can be selected.

- Autoflash
- Autoflash with red-eye reduction
- Manual fill-flash
- Flash cancel
- Night portrait
- Landscape and

Press the flash-mode button until the desired indicator appears in the data panel.

- The flash mode remains after the picture is taken.

AUTO AUTOFLASH MODE

In autoflash mode, the flash fires automatically in low-light situations.

RED-EYE REDUCTION MODE

In this flash mode, the flash fires automatically in low-light situations and the red-eye reduction lamp on the front of the camera blinks before the flash fires. Red-eye reduction reduces the "red-eye" effect which occurs when photographing people in low light.

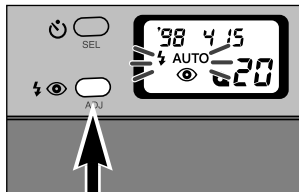

Press the flash mode button until appears in the data panel.

- Warn your subject that the red-eye reduction lamp will blink before the picture is taken.



MANUAL FILL-FLASH MODE

The flash will fire with every shutter release regardless of lighting. This can be used to reduce harsh, unflattering shadows on your subject's face or illuminate your subject when it is back-lit.

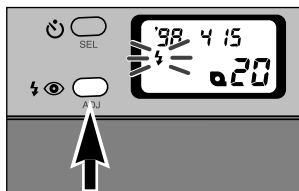

Press the flash-mode button until appears in the data panel, then take the picture.

FLASH CANCEL MODE

With flash-cancel, the flash will not fire. This mode should be used when photographing twilight scenes or subjects that are beyond the flash range.

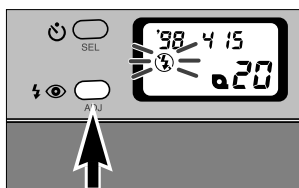

Press the flash-mode button until appears in the data panel, then take the picture.

- When the flash is canceled, shutter speeds may be slow. Placing your camera on a tripod is recommended.

NIGHT PORTRAIT MODE

In night portrait mode, the camera balances the flash and existing light exposure so you can take beautiful pictures of people at sunset or at night. The flash is set to manual fill flash with red-eye reduction.

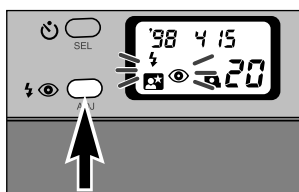

Press the flash mode button until appears in the data panel.

- The shutter speed may be slow. Use of a tripod is recommended.

LANDSCAPE MODE

Use landscape mode to photograph distant scenes that are beyond the range of the flash or when photographing through glass. The flash is canceled and focus is set to infinity.

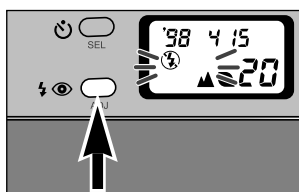

Press the flash mode button until and appear in the data panel.

- The shutter speed may be slow. Use of a tripod is recommended.



SELF-TIMER

The self-timer delays release of the shutter for approximately 10 seconds after the shutter-release button is pressed.

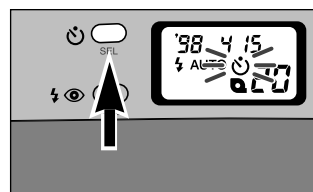

1. Place the camera on a tripod and press the self-timer button until appears in the data panel.



2. Center your subject in the focus frame, then press the shutter-release button.

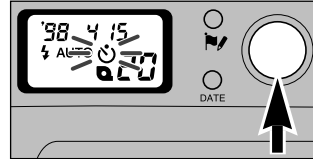

- The self-timer indicator in the data panel and the self-timer lamp will blink during the countdown, then glow just before the shutter releases.
- Self-timer is automatically canceled after the shutter is released.
- To stop the self-timer, press the self-timer button. Cancel the self-timer mode by turning the camera off or pressing the self-timer button until disappears from the data panel.

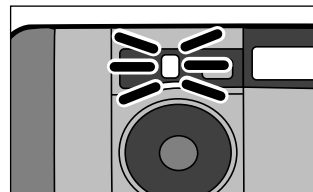

DATE/TIME IMPRINTING

Your camera records date and time information on the film's magnetic strip that certified photofinishers can imprint in the front and back of your photographs.

- Some labs can not imprint date and/or time information on the front of your photographs. See your photofinisher for a full description of available services.
- This camera has a quartz clock and automatic calendar through the year 2029.

IMPRINTING THE DATE OR TIME

***With the camera on and before taking the picture:**

Press the date button until the data panel displays the format you want to see on the print.

***The sequence is as follows:**

→ DATE → TIME → --- (no display)

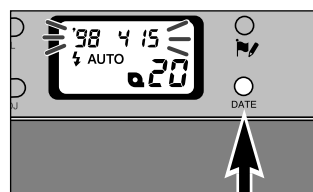
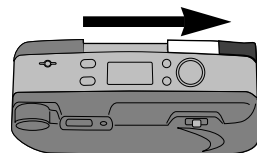

- When --- is displayed in the data panel, no data will be printed on the front of the print, but the date and time of exposure will be imprinted on the back of the print.
- If the date/time display is blinking, date/time information will not be imprinted. The date/time information needs to be reset.

SETTING THE DATE AND TIME

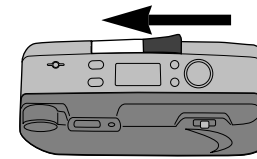

1. Close the front cover to turn the camera off.

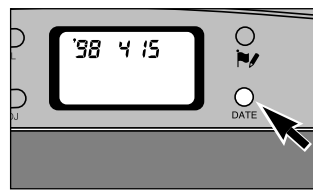

2. Press the date button to display the date.

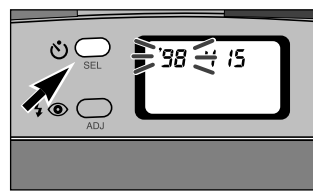

3. Press the select button until the item you want to change blinks.

- Each press of the select button causes the next item to blink.

The sequence is:
year - month - date - hour - minute - stops blinking

4. Press the adjust button to change the blinking item.

- Press and hold the adjust button to change the value rapidly.

5. Repeat steps 3 and 4 until all items are correct.

6. Press the date button to set the updated information.

CHANGING THE DATE/TIME FORMAT

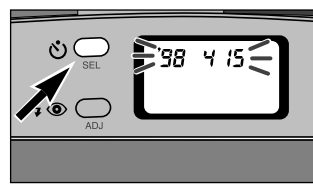

1. Close the front cover to turn the camera off.
2. Press the date button to display the date.
3. Press and hold the select button until all items in the date display blink.

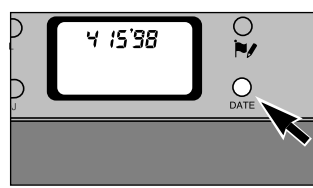

4. Press the adjust button to change the display format.

- The format sequences as follows:
D M Y → Y M D → M D Y

5. Press the date button to set the selected format.



TITLE IMPRINTING

Two titles from the title list can be preset for use while taking pictures. Either of the two preselected titles can be selected before the picture is taken. The selected title is recorded on the film's magnetic strip, then printed on the back of the print by your certified Advanced Photo System lab.

- Some labs may not be able to print the titles in all of the available languages. See your photofinisher for details.
- Titles are displayed in the data panel as a title code. Please refer to the Title List for the titles available with this camera.

*With the camera on and before taking the picture:

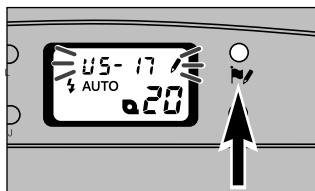

1. Press the title button to display the code for the title you want.

*The sequence is as follows:

→ Title-1 → Title-2 → - - - - (no display)

2. Take the picture. The magnetic data is written and the selection is canceled for the next frame.

PRESELECTING TITLES

Two title codes have been set into memory. You can change one or both title codes at any time.

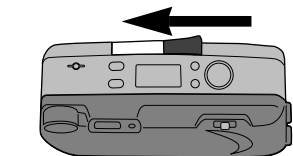

1. Close the front cover to turn the camera off.
2. Select the code for the title you want from the title list.



3. Press the title button to display the title code you want to change.

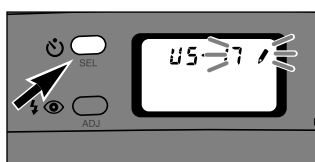

4. Press the select button, the last digit of the title code number will blink.

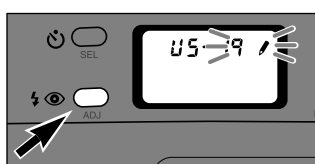

5. Press the adjust button to change its value.
 - Press and hold the adjust button to change the value rapidly.

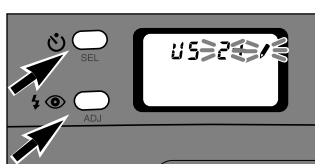

6. Press the select button to make the next digit blink, change its value using the adjust button.

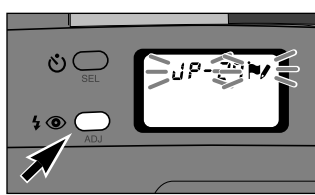

7. Press the select button to make the language code blink.
8. Press the adjust button to change the language code.

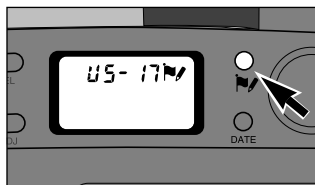

9. When the title information is correct, press the title button.

LAB SERVICES



To receive the best possible prints, take your film to a photolab displaying the Certified Advanced Photo System logo. Photofinishers displaying this logo have been certified according to Advanced Photo System guidelines.

Certified photolabs will be able to provide the following services.

1. CHP - Print Format

Your film will be printed according to the format set when the picture was taken.

2. Date and Title Imprinting

The date, time, and selected title are printed on the back of the picture in the chosen format.

3. PQI - Print Quality Improvement

The lab will compensate (or not compensate) printing according to the data recorded on the magnetic data strips.

4. Film is returned in the cassette

To keep the film dust free and aid in organization, film is returned in its original film cassette. The VEI will be set to ■ to prevent accidental loading

5. Index Print

An index print showing a numbered image of each frame is included with your returned order.

REPRINTS

Images are always captured in the H format (High-Vision). You can select any of the three formats when ordering reprints.

CARING FOR YOUR CAMERA

CLEANING

- Keep the AF and AE windows clean or the focus and/or exposure may not be accurate.
- If the camera body is dirty, gently wipe it clean with a soft, clean, dry cloth.
- To clean the lens surface, first brush away any dust or sand then, if necessary, moisten a lens tissue with lens cleaning fluid and gently wipe the lens in a circular motion, starting from the center.
- Never place lens fluid directly on the lens.
- Never touch the lens surface with your fingers.
- Never use alcohol or solvents to clean the camera.

STORAGE

When storing the camera for extended periods of time, please follow these guidelines,

- Store the camera in a cool, dry, well-ventilated area away from dust and chemicals. For very long periods, place the camera in an airtight container with a silica gel drying agent.
- Before using after prolonged storage, always check the camera's operation to make sure it is functioning properly.

QUESTIONS AND SERVICE

- If you have questions about your camera, contact your local camera dealer or write to the Minolta distributor in your area.
- Do not open the film chamber or forcefully remove the cassette if the film cannot be rewound. Contact an authorized Minolta Service Facility.
- Before shipping your camera for repair, please contact an authorized Minolta Service Facility for details.

BEFORE IMPORTANT EVENTS

- Check camera operation carefully or take test photographs.
- Minolta is not responsible for any loss which may occur due to an equipment malfunction.

FILM CASSETTE WARNING

The film used in Advanced Photo System cameras stores some data magnetically. Do not place the cassette on or near anything that creates a magnetic field, such as a television or stereo speakers.

CAMERA ERROR

If all the indicators in the data panel blink, or the data panel is blank and the camera will not function with a fresh battery, remove and reinsert the battery. If normal operation does not resume, or the camera malfunctions repeatedly, contact an authorized Minolta Service Facility.

TECHNICAL SPECIFICATIONS

Camera Type:	IX240 Lens Shutter Camera
Lens:	25-50mm f/4.8-9.1 power zoom lens
Focusing range:	C/H: 0.5m - (1.64 ft -) P Wide: 0.5m - (1.64 ft -), P Tele: 1.0m - (3.28 ft -)
Film speed range:	ISO 25-3200
Metering range (ISO 200):	25mm: EV 4 - 16.2, 50mm: EV 4 - 17;
Flash range(ISO 200):	25mm: 0.5 - 5.0m (1.64 ft.- 16.4 ft.), 50mm: 0.5 - 2.7m (1.64 ft. - 8.85 ft.)
Battery:	One 3-volt CR2 lithium battery
Battery-condition indication:	3-stage indication
Battery performance:	Approx. 12 rolls (25 exp. roll w/ 50% flash)
Viewfinder:	Magnification: 0.32X - 0.6X Field of View (H format): 85% for subject at 3m (9.38 ft.)
Dimensions:	104 x 65 x 39mm (4-1/8 x 2-5/8 x 1-5/8 in.)
Weight:	170g (6.0 oz.)

Specifications are based on the latest information available at the time of printing and are subject to change without notice.

This device complies with Part 15 of the FCC Rules. Operation is subject to the following two conditions: (1) This device may not cause harmful interference, and (2) this device must accept any interference received, including interference that may cause undesired operation. Changes or modifications not approved by the party responsible for compliance could void the user's authority to operate the equipment. This equipment has been tested and found to comply with the limits for a Class B digital device, pursuant to Part 15 of the FCC Rules. These limits are designed to provide reasonable protection against harmful interference in a residential installation. This equipment generates, uses and can radiate radio frequency energy and, if not installed and used in accordance with the instructions, may cause harmful interference to radio communications. However, there is no guarantee that interference will not occur in a particular installation. If this equipment does cause harmful interference to radio or television reception, which can be determined by turning the equipment off and on, the user is encouraged to try to correct the interference by one or more of the following measures:

- Reorient or relocate the receiving antenna.
- Increase the separation between the equipment and the receiver.
- Connect the equipment to an outlet on a circuit different from that to which the receiver is connected.
- Consult the dealer or an experienced radio/TV technician for help.

This Class B digital apparatus meets all requirements of the Canadian Interference-Causing Equipment Regulations.

This mark on your camera certifies that this camera meets the requirements of the EU (European Union) concerning interference causing equipment regulations. CE stands for Conformité Européenne (European Conformity).