

RIVA ZOOM 90c FREEDOM ZOOM 90c

INSTRUCTION MANUAL

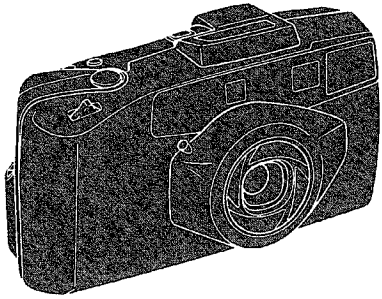

MINOLTA

Congratulations on purchasing this unique zoom-compact camera. Based on state-of-the-art lens design, it gives you the advantages of a zoom lens in an exceptionally compact camera body.

Apart from its 38-90mm zoom lens, the camera's other features include an autozoom system that you can activate simply by looking through the viewfinder, versatile flash control, and a self-timer.

Before using the camera, please take the time to read through this manual; doing so will enable you to take full advantage of its features, right from the start.

TABLE OF CONTENTS

Names of Parts	2
Viewfinder	4
Data Panel	5
Getting Started	
1. Power	6
2. Film	10
3. Holding the Camera	14
4. Shutter-Release Button	15
5. Taking a Picture	16
6. Film Rewind	18
Operation in Detail	
7. Auto Standby Zoom	19
8. Manual Zoom Control	22
9. Focus Hold	24
10. Taking Closeup Pictures	26
11. Flash	28
12. Self-Timer	34
Troubleshooting	36
Attaching the Neckstrap	38
Optional Accessories	39
Care and Storage	40
Technical Details	42

NAMES OF PARTS

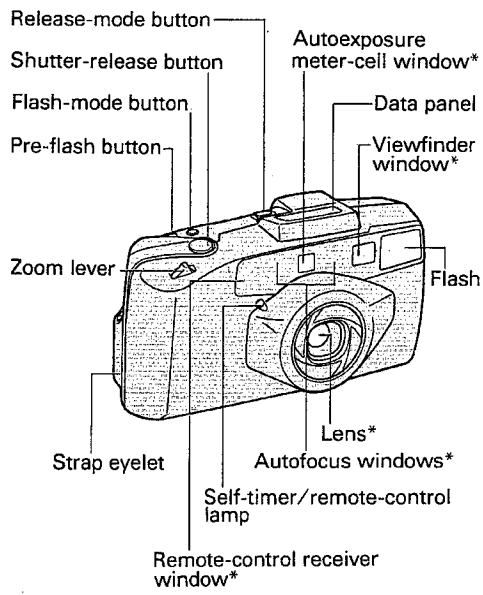

* Do not touch

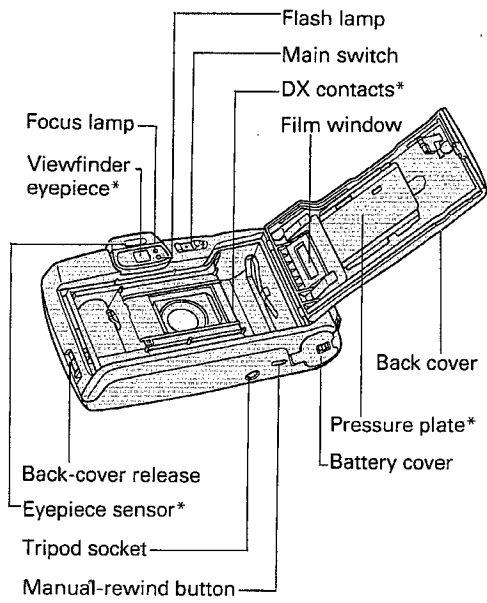

VIEWFINDER

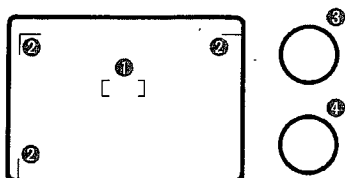

- ① **Focus frame:** for focusing, should be centered on your main subject
- ② **Close-framing guides:** should be used for framing subjects nearer than 1.4 meters (4.6ft.) from the camera when the zoom position is greater than 56mm
- ③ **Focus lamp (green):** glows to indicate focus/exposure lock when the shutter-release button is pressed partway down; if the detected subject distance is less than the minimum focus distance, blinks when the shutter-release button is pressed partway down
- ④ **Flash lamp (orange):** operates when the viewfinder is brought to eye level according to the flash settings and lighting conditions; in **auto-flash** and **manual-fill flash** modes glows (pre-flash off) or blinks at varying intervals (pre-flash on) to indicate that a flash exposure will be made; blinks 8 times per second (8 Hz) to indicate flash charging in progress; when **flash-off** is selected, blinks twice per second (2 Hz) to recommend use of flash

4

DATA PANEL

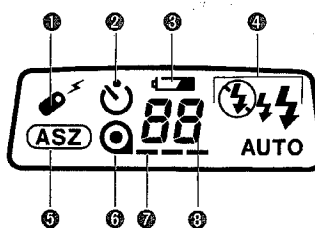

- ① **Remote-control indicator:** displayed when remote-control operation is set (separately available remote control required)
- ② **Self-timer indicator:** displayed when self-timer operation is set
- ③ **Low-battery indicator:** displayed when battery power is low
- ④ **Flash-setting indicator:** displays current flash setting
- ⑤ **ASZ indicator:** displayed when **ASZ** is set
- ⑥ **Film-cartridge mark:** displayed when film is loaded; blinks when rewind is complete
- ⑦ **Film-transport signals:** displayed while film is extended from the film cartridge
- ⑧ **Frame counter:** displays the current frame number

5

GETTING STARTED

1. POWER

Your Freedom Zoom 90c/Riva Zoom 90c uses a six-volt 2CR5 lithium battery that supplies power for all camera operations.

Battery Installation

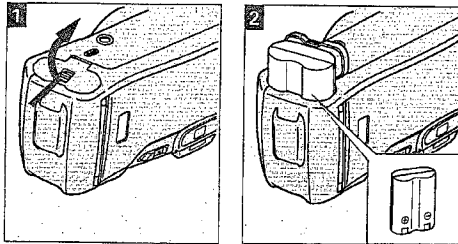

- 1 Slide the battery-cover release in the direction shown to open the battery cover.
- 2 Insert the battery as shown, then snap the battery cover closed.

If necessary, wipe the battery terminals with a dry cloth to ensure proper contact.

Main Switch

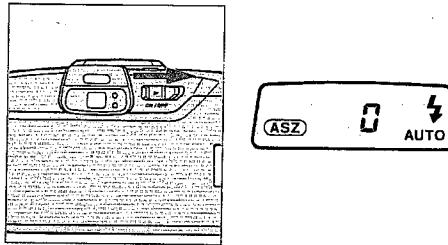

The camera is switched on and off by sliding the main switch in the direction shown; when you release the switch, it returns to its rest position.

When the camera is switched on, the lens cover opens automatically and various indicators are displayed in the data panel; similarly, switching the camera off automatically closes the lens cover and the data panel display disappears. The shutter remains locked when the camera is switched off.

Low-Battery Indicator

The battery level is automatically checked when the camera is switched on and, subsequently, when any of its controls are operated. If power is low, the battery condition will be reflected in the data panel as follows:



Blinking low-battery symbol appears with other indicators: Camera can be operated, but the battery will need to be changed soon.



Blinking low-battery symbol alone is displayed: Power is too low for normal operation, and the shutter remains locked—replace the battery.

If the data panel remains completely blank when the camera is switched on, replace the battery.

- If you take many flash pictures in succession, blinking low-battery symbol may appear even with a fresh battery. In this case, wait for a moment; the low-battery symbol will disappear from the display, and you can resume operation.

Auto Power Off

To conserve power, the camera automatically shuts itself off if not operated for more than three minutes. To restore the data panel display and resume operation, simply slide the main switch.

Battery Cautions

- Read and follow all warnings and instructions supplied by the battery manufacturer.
- Keep batteries away from children.
- Do not attempt to disassemble, recharge, or short out the battery, or subject it to high temperatures or fire. The battery may explode and cause burns.

2. FILM

Automatic Film Speed Setting

Only 35mm film can be used in this camera. We recommend using only DX-coded (DX is printed on the film cartridge) ISO 25 to 3200 films, for which the correct ISO speed will be automatically set.

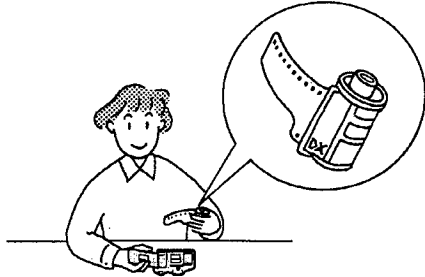

- Film-cartridges without DX coding, 72-exposure cartridges, and Polaroid instant 35mm films cannot be used.
- If you insert the battery after loading film, the film will not advance.. Make sure to load the battery prior to loading film.

10

Loading Film

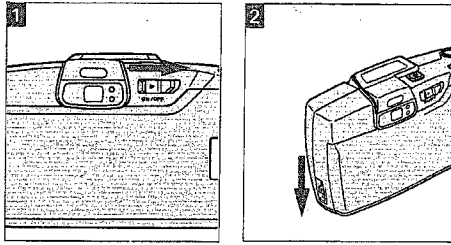

- 1 Slide the main switch to turn the camera on.
- 2 Use the back-cover release to open the back cover, as shown.

- Before opening the back cover, check that **0** is displayed in the frame counter; if not, film is already loaded and the camera should not be opened. The type of film loaded can be verified by checking the film window. (Refer to p.18 for instructions on rewinding an unfinished roll of film.)
- Load film in subdued light, or at least shaded from direct sunlight.

11

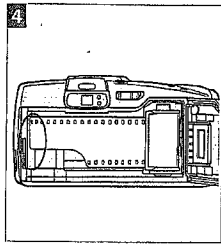
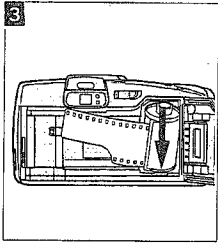

3 Place the film cartridge into the film chamber as shown.

4 Lay the film flat between the guide rails and extend the tip of the film over the take-up drum to the film mark.

Right

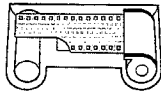

Wrong

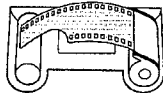

- Make sure the tip of the film is shaped correctly; otherwise, the film may not wind properly.
- If the film extends too far, gently push the excess back into the cartridge.

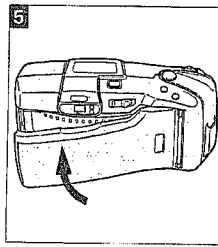

5 Close the back cover.

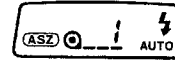

The film will advance automatically to the first frame. When 1 appears in the frame counter, the camera is ready for taking pictures.

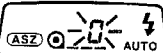

If the film is incorrectly loaded, the frame counter will remain at 0 and blink. Open the back cover and repeat steps 2 through 5.

3. HOLDING THE CAMERA



To obtain sharp, blur-free photos, hold the camera as still as possible and steady it against your face or body. To take pictures, press the shutter-release button gently with a slow, steady squeeze — never a quick jab.

Two recommended ways of holding the camera are shown here. For vertically framed pictures, make sure to hold the camera so that the flash is on top.

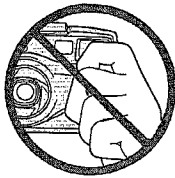

When taking pictures, be sure to keep your fingers clear of the flash.

4. SHUTTER-RELEASE BUTTON

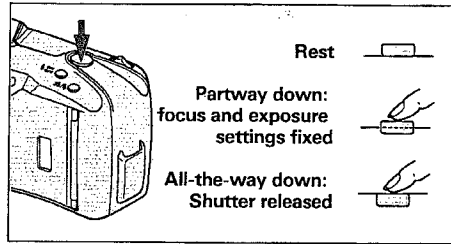

In describing camera operation, this manual refers to two shutter-release-button operating positions: a pre-release “partway-down” position that can be used to memorize current focus and exposure settings (see Focus Hold, p.24), and an “all-the-way” down position that triggers the shutter-release sequence. Both operating positions, as well as the rest position, are illustrated above.

5. TAKING A PICTURE

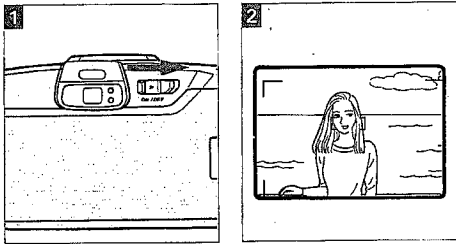

This section provides a basic description of camera operation, enough to get you started taking pictures. A more complete explanation, as well as information on optional features, can be found in **Operation in Detail**.

- 1 Slide the main switch to turn the camera **ON**.
- 2 Looking through the viewfinder, center the focus frame on your subject.

- When you look through the viewfinder the lens zooms automatically, based on your subject's distance from the camera. Refer to p.19 for details on ASZ operation.
- If ambient lighting conditions require the use of flash, the orange flash lamp will glow when the camera is brought to eye level, and flash will fire when the picture is taken. Refer to p.28 for details on flash operation.

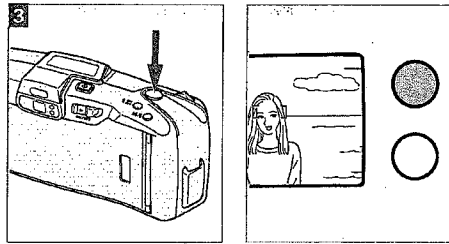

- 3 Press the shutter-release button partway down so that the focus lamp glows, then all-the-way down to take the picture.

After you take a picture the film is automatically advanced and the frame counter increases by one.

- The camera's minimum focus distance is 0.75 meters (2.5 feet) when the lens is set to its wide position (38mm), and 0.9 meters (3.0 feet) when set to its tele position (90mm). Be sure to check that your subject is not closer than the applicable minimum focusing distance. Refer to p.26 for additional information on taking closeup pictures.
- When done taking pictures, be sure to switch the camera off to conserve battery power.

6. FILM REWIND

Automatic Film Rewind

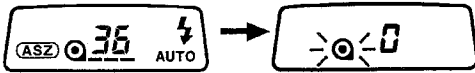

After the last frame on the roll is exposed, the camera automatically starts rewinding the film. While rewind is in progress, the frame counter counts down to 0.

Completion of film rewind is indicated in the data panel: 0 will be displayed by the frame counter, and the film-cartridge mark blinks. Open the back cover and remove the film. The shutter remains locked if a rewind film cartridge is left in the film chamber.



Manual Start of Film Rewind

You can also rewind a roll of film before the last picture is taken. To start film rewind manually, use a ball-point pen or similar object to press the rewind button located on the bottom of the camera.

OPERATION IN DETAIL

7. AUTO STANDBY ZOOM (ASZ)

When you switch the power on and look through the viewfinder, the camera automatically measures the distance to your subject and sets a zoom position based on that distance. ASZ is the system that integrates these functions.

Eye Start Operation

Automatic zoom control is activated by an eyepiece sensor located just above the viewfinder eyepiece. Whenever the sensor detects an object closer than approximately 6 to 8 cm (2-3/8 to 3-1/8 in.), automatic zoom control is switched on.

- When detection by the eyepiece sensor is interrupted following an exposure, the zoom position is automatically reset to 38mm; ASZ operation will resume immediately when the camera is brought to eye level.
- If you rest the camera following ASZ operation without taking a picture, the current lens position remains set.

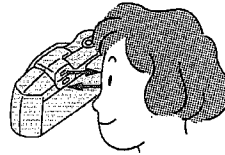

ASZ's automatic zoom control is switched on by an eyepiece sensor that detects when you look through the viewfinder.

Automatic Zoom Control

By automatically adjusting the zoom position when you look through the viewfinder, ASZ saves time in setting up a picture. The zoom position set is based on subject distance, which is rapidly calculated by the AF system when the camera is brought to eye level. In many cases the ASZ zoom setting will be just right for your subject, and all that remains is to press the shutter-release button down to take the picture.

At other times, you may want to use a zoom position other than that set by ASZ, and for these cases manual zoom control, described in the following section, should be used.



ASZ's zoom control is based on subject distance.

ASZ's working range is approximately 0.75-8m (2.5-26ft.); for subjects within this range, a distance-based zoom position will be automatically set when you frame the subject in the viewfinder. When the camera-subject distance is greater than 8m (26ft.), the lens focal length will be set to the tele position (90mm).

ASZ Working Range

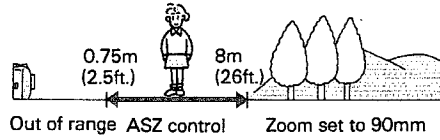

9. FOCUS HOLD

Focus hold enables you to adapt autofocus for situations where your main subject is positioned outside the center of the viewfinder frame. It is also useful for photographing certain types of subjects, described below, that cannot be auto-focused directly.

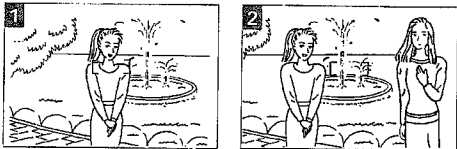

Off-Center Subjects

1 Center the focus frame on your subject, then press the shutter-release button partway down so that the focus lamp glows.

2 Keeping the shutter-release button held partway down so that the focus lamp continues to glow, recompose the frame as desired and then press all-the-way down to take the picture.

- While the focus lamp glows, current focus and exposure settings are fixed.
- Focus hold is easily canceled by removing your finger from the shutter-release button.

Focusing in Special Situations

Focus hold should also be used whenever your subject falls into any of the following categories:

- Bright light sources such as the sun or neon lights
- Highly reflective surfaces such as water, mirrors, etc. (A)
- Flame, fireworks, etc.
- Dark objects and surfaces with low reflectance
- Objects behind glass, bars, or other such partitions (B)
- Objects significantly smaller than the focus frame as seen through the viewfinder

In such cases, use focus hold to set the focus distance on another object at the same distance from the camera as your subject.

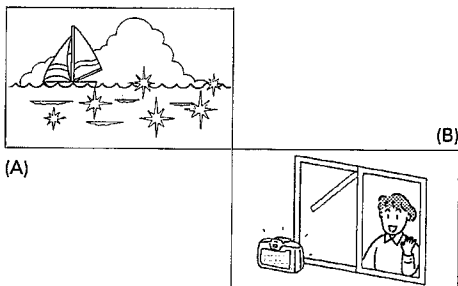

10. TAKING CLOSEUP PICTURES

Your Minolta Freedom Zoom 90c/Riva Zoom 90c lets you take pictures of subjects as near as 0.75m (2.5ft.) from the camera when the zoom is set to wide, or 0.9m (3.0ft.) at the tele position.

Closeup operation is illustrated in the two diagrams below, one for wide to normal zoom settings (approximately 38-56mm range), and the other for normal to tele (approximately 57-90mm).

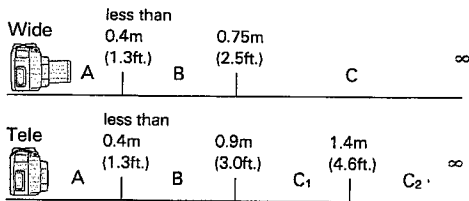

A: Although ASZ operates and the shutter can be released, pictures taken in this range will **not be in focus**.

B: This region is just below the camera's near focusing distance; whenever the camera detects a subject within this range, the focus lamp blinks and the shutter remains locked. You will be able to resume operation by increasing the camera-subject distance so that it falls within region C.

C: This region indicates the camera's operating range, extending from infinity down to the near focusing distance, within which the camera can give you sharply focused pictures. In the diagram, applicable for focal lengths greater than 56mm, this region is further subdivided into regions C₁ and C₂. Within region C₂, operation is as usual; for subjects within region C₁, you should compose your subject in the viewfinder using the close-framing guides.

Close-framing guides

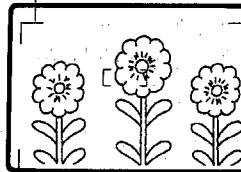

11. FLASH

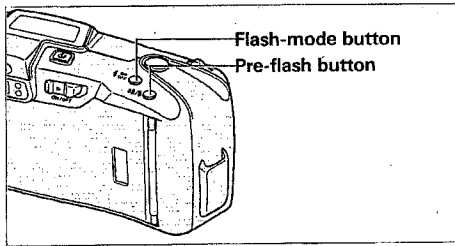

The flash-mode and pre-flash buttons enable you to tailor flash operation to suit a variety of photographic situations.

The flash-mode button allows you to select between autoflash, manual-fill flash, and flash-off modes, and the pre-flash button enables you to switch the camera's red-eye-reduction control on and off as desired.



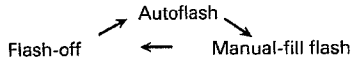

By pressing the flash-mode button successively, the flash mode changes as shown

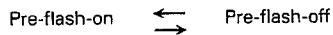

Pressing the pre-flash button enables you to turn the camera's pre-flash function on and off



Depending on your choice of flash mode and pre-flash settings, five different flash-control positions are possible:

-  AUTO Autoflash
-  AUTO Autoflash with pre-flash
-  Manual-fill flash
-  Manual-fill flash with pre-flash
-  Flash-off

Autoflash is the flash-mode default position, set each time the camera is switched on; pre-flash will be set to on or off according to the position set at the time the camera was switched off (the first time you switch the camera on, or after loading a new battery, pre-flash off will be set). At any point in the course of operation, the current flash setting can be confirmed by referring to the data panel's flash-setting indicator.

Flash Mode

Autoflash ()

In autoflash mode, the flash fires whenever needed. When you look through the viewfinder, the metering system evaluates the ambient lighting. In cases where it determines that flash is needed, it will be fired automatically when the picture is taken.

Manual-Fill Flash ()

The autoflash mode described above provides dependable operation for general photographic situations, including firing the flash under bright conditions to fill in subject shadows when sufficiently strong backlight is detected.

In certain cases, however, selecting manual-fill flash mode, where the flash fires each time a picture is taken regardless of ambient lighting conditions, may give improved results. One example might be cases where a subject's features are obscured by small or light shadows not sufficient to activate auto fill-flash. Another would be situations where your subject is illuminated by a fluorescent light source that might otherwise produce a greenish picture cast.

Flash-Off ()

In certain situations non-flash photography may be preferred—for instance, when photographing twilight scenes, or if taking pictures inside a museum.

When flash-off mode is selected, the flash remains off regardless of the ambient lighting. In cases where the metering system judges that flash should be used, however, the flash lamp blinks twice per second (2Hz) when you frame the subject in the viewfinder.

When flash-off mode is selected, shutter speed will be slower; use of tripod is recommended.

Pre-Flash ()

When pre-flash is selected, a low level flash burst is fired just before each flash picture. By causing the diameter of your subject's pupils to narrow before the actual exposure, pre-flash reduces the appearance of red eye in the picture.

12. SELF-TIMER

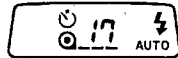
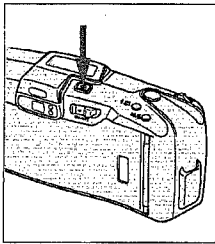

To set a ten-second delay in shutter release, press the release-mode button so that the self-timer indicator () is displayed in the data panel. Frame your subject in the viewfinder as desired, then press the shutter-release button down in the usual way to take the picture. Both the self-timer lamp on the front of the camera and the data panel indicator will begin blinking to indicate operation, and the picture will be taken about ten seconds later.

- Selecting self-timer operation sets a temporary cancellation of ASZ, indicated by the disappearance of the ASZ indicator from the data panel. Once self-timer operation is set, use the zoom lever to frame the scene as desired. After the picture is taken, ASZ is automatically restored.
- To cancel the self-timer prior to pressing the shutter-release button, press the release-mode button a second time. To cancel the self-timer once the shutter-release button has been pressed, but before the picture has been taken, switch the camera off.

TROUBLE SHOOTING

Problem	Cause	Solution	Page
Entire picture blurred	① Camera Movement	① Hold camera steady and release shutter gently.	14
Subject out of focus	① Autofocus windows obstructed	① Keep hands, camera strap, and other objects away.	14
	② Subject too close to camera	② Check that the subject is beyond the minimum focusing distance.	26
	③ Focus frame not on main subject	③ Use focus hold.	24
	④ Special focusing situation	④ Use focus hold on another subject that is an equal distance away.	25
Picture foggy or has blurry areas	① Dirty Lens	① Clean lens as explained in Care and Storage section.	40
Picture too dark, or partial picture	① Lens or flash obstructed	① Keep hands, camera strap, and other objects away.	14
	② Subject beyond flash range	② In low light, make sure subject is within flash range.	33
Shutter cannot be released	① Camera switched off	① Switch camera on.	7
	② Battery is exhausted	② Replace battery.	6, 8
	③ Flash charging	③ Wait a moment for the flash to charge.	32
	④ Subject too close to camera	④ Check that the subject is beyond the minimum focusing distance.	26
	⑤ Rewind is complete but film cartridge remains in the camera	⑤ Remove film.	18
	⑥ Circuit fault	⑥ Remove and reinstall the battery.	6
ASZ does not function	① Self-timer or remote control operation set	① Cancel operation as needed.	35
	② Override set	② Restore ASZ as explained in section 8.	23
Frame counter blinks during operation and the shutter cannot be released	① Winding malfunction	① Rewind the film by pressing the rewind button.	18

ATTACHING THE NECKSTRAP

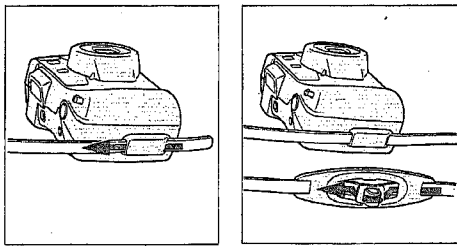

Attach the supplied neckstrap to the camera's strap eyelet as illustrated above.

OPTIONAL ACCESSORIES

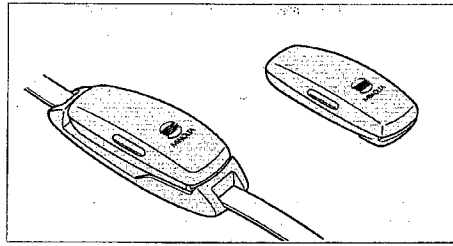

IR Remote Control RC-1

A convenient wireless infrared remote control, designed exclusively for the Freedom Zoom 90c/Riva Zoom 90c, is available as an optional accessory. The remote control features single-frame and double-frame release modes, and works at distances of up to 6m (20ft.) from the camera.

For operating information, refer to the instruction manual provided with the remote control.



CARE AND STORAGE

- If the lens becomes dirty, clean it gently with a lens brush. If necessary, moisten a sheet of lens tissue with one drop of lens-cleaning fluid and gently wipe the lens. Never touch the lens surface with your fingers.
- Never use alcohol or chemical solvents on the camera body. If it is dirty, wipe it gently with a soft, clean, dry cloth.
- Never subject the camera to shock, high heat, or humidity. Be particularly careful not to leave it in the glove compartment or other places in motor vehicles where it may be subjected to high temperatures.
- Entry of sand, salt, or other grit may cause costly or irreparable damage to the camera. Use extra care when taking pictures at the beach.
- This camera is designed for use between -10 and $40^{\circ}\text{C}/14$ to 104°F .
- Using the camera at very low temperatures impairs its performance. In cold weather, carry the camera inside your coat to keep it warm. Do not transfer the camera directly from an extremely cold to warm area, since condensation may form inside and prevent normal operation.
- Do not let the camera get wet. Water seepage could result in costly or irreparable damage to internal parts.

- When not in use, keep the camera in a cool, dry place away from dust and chemicals. For extended storage we recommend that you place the camera in an airtight container with a drying agent such as silica gel.
- This camera contains high-voltage circuits. Do not attempt to disassemble or repair it yourself.
- If you have questions about your camera, contact your local camera dealer. For more information write to the Minolta distributor or subsidiary in your area (addresses listed at the back of this manual).
- To assure prompt service, please contact an authorized Minolta Service Center before shipping your camera for repairs.

TECHNICAL DETAILS

Type: 35mm autofocus lens-shutter camera

Lens: 38-90mm f/3.5-7.7 power zoom lens

Autofocus System: 3-beam infrared type with cancelable focus hold; range: 0.75m/2.5ft. (38-56mm), 0.9m/3.0ft. (57-90mm) to infinity

Zoom Control: Sensor-activated Auto Standby Zoom (ASZ) sets a zoom position based on subject distance; zoom lever for manual override

Metering System: External, two-segment silicon photocell for separate illuminance readings of center and background picture areas

Autoexposure: Programmed autoexposure; range (ISO 100): EV 6 to EV 17 (1/4 sec at f/3.5 to 1/350 sec at f/19) at 38mm setting, EV 8 to EV 17 (1/4 sec. at f/7.7 to 1/250 sec. f/22) at 90mm setting

Flash System: Built-in flash with auto, manual, and flash-off modes selectable; **autoflash:** flash fires automatically when required; **manual-fill flash:** flash fires on each exposure; range (ISO 100): 0.75-6.0m/2.5-20ft. at 38mm, 0.9-3.0m/3.0-9.8ft. at 90mm; with pre-flash control selected, a low-power pre-exposure flash burst is given approximately 0.75 secs. before each flash exposure; recycling time: 3.5 sec

Film Speed: Automatic setting for DX-coded ISO 25-3200 film

Viewfinder: Real-image type with focus frame, close-framing guides; magnification: 0.45X at 38mm, 0.95X at 90mm; image area: 85% coverage; eyepiece LED lamps show focus and flash status

Controls: Main switch; zoom lever for powered manual zoom; flash-mode button; pre-flash button; release-mode button; manual rewind button; focus and exposure settings fixed when shutter-release button is held partway down

Film Transport: Automatic threading, auto advance to first frame, auto winding, auto rewind and auto rewind stop; rewind button for manual start of rewind

Data Panel: LCD with indications for ASZ, remote-control, self-timer, battery condition, flash mode, frame number, film transport, film loaded

Self-Timer: 10-sec. shutter-release delay; operation indicated by blinking LED on front of camera and data panel self-timer indicator

Power: 6V lithium battery pack (2CR5) powers camera operation; data-panel indicator shows battery condition; shutter remains locked when battery is exhausted

Battery Performance: Approximately 25 rolls (based on Minolta's standard test method, using 24-exposure film with flash on 50% of the exposures)

Dimensions: 147.5(W) X 73.5(H) X 59.5(D)mm
(5-13/16 X 2-7/8 X 2-5/16 in.)

Weight (without battery): 320g (11-5/16 oz.)

Optional Accessories: IR Remote Control RC-1

Specifications and accessories are based on the latest information available at the time of printing and are subject to change without notice.

STATEMENT OF FCC COMPLIANCE

This device complies with Part 15 of the FCC Rules. Operation is subject to the following two conditions: (1) This device may not cause harmful interference, and (2) this device must accept any interference received, including interference that may cause undesired operation. Changes or modifications not approved by the party responsible for compliance could void the user's authority to operate the equipment. This equipment has been tested and found to comply with the limits for a Class B digital device, pursuant to Part 15 of the FCC Rules. These limits are designed to provide reasonable protection against harmful interference in a residential installation. This equipment generates, uses and can radiate radio frequency energy and, if not installed and used in accordance with the instructions, may cause harmful interference to radio communications. However, there is no guarantee that interference will not occur in a particular installation. If this equipment does cause harmful interference to radio or television reception, which can be determined by turning the equipment off and on, the user is encouraged to try to correct the interference by one or more of the following measures:

- Reorient or relocate the receiving antenna.
- Increase the separation between the equipment and receiver.
- Connect the equipment into an outlet on a circuit different from that to which the receiver is connected. Consult the dealer or an experienced radio/TV technician for help.

STATEMENT OF DOC COMPLIANCE

This digital apparatus does not exceed the Class B limits for radio noise emissions from digital apparatus set out in the Radio Interference Regulations of the Canadian Department of Communications.

Minolta Camera Co., Ltd.

3-13, 2-Chome, Azuchi-Machi, Chuo-Ku, Osaka 541, Japan

Minolta GmbH

Kurt-Fischer-Strasse 50, D-2070
Ahrensburg, Germany

Minolta France S.A.

365-367 Route de Saint-Germain,
78420 Carrières-Sur-Seine, France
1-3 Tanners Drive, Blakelands North,
Milton Keynes, MK14 5BU, England

Minolta (UK) Limited

Minolta Austria Gesellschaft m.b.H.

Minolta Camera Benelux B.V.

Amalienstrasse 59-61, 1131 Wien, Austria
Zonnebaan 39, 3606 CH Maarssenbroek,
P.B. 264, 3600 AG Maarssen,
The Netherlands

Belgium Branch

Stenen Brug 115-117, 2200 Antwerpen,
Belgium

Minolta (Schweiz) AG

Riedhof V, Riedstrasse 6 8953 Dietikon-
Zürich, Switzerland

Minolta Svenska AB

Brännkyrkagatan 64, Box 17074,
S-10462 Stockholm 17, Sweden

Minolta Corporation
Head Office

101 Williams Drive, Ramsey,
New Jersey 07446, U.S.A.

Los Angeles Branch

11150 Hope Street
Cypress, CA 90630, U.S.A.

Chicago Branch

3000 Tollview Drive,
Rolling Meadows, IL 60008, U.S.A.

Atlanta Branch

5904 Peachtree Corners East,
Norcross, GA 30071, U.S.A.

Minolta Canada Inc.
Head Office

369 Britannia Road East, Mississauga,
Ontario L4Z 2H5, Canada

Montreal Branch

3405 Thimens Blvd., St. Laurent,
Quebec H4R 1V5, Canada

Vancouver Branch

106-3830 Jacobs Road, Richmond, B.C.
V6V 1Y6, Canada

Minolta Hong Kong Limited

Room 208, 2/F, Eastern Center, 1065
King's Road, Quarry Bay, Hong Kong

Minolta Singapore (Pte) Ltd.

10, Teban Gardens Crescent,
Singapore 2260



© 1991 Minolta Camera Co., Ltd. under the Berne
Convention and Universal Copyright Convention

44 .402-11

P107-A1 Printed in Japan